

# SYSTEMS FOR PRIVATE SPA

Programme · Prices in Euro excl. VAT · effective January 1, 2023



# Welcome to LUX ELEMENTS



The family-owned company LUX ELEMENTS is an experienced specialist in the production of polystyrene hard foam and its further processing into secure substrates for bathrooms and wellness areas. For the sake of the environment, the company has been using a manufacturing process without the use of CFCs, HCFCs, HFCs or CO<sub>2</sub> propellant gases for more than two decades.

The product range is based on the ground-breaking invention of company founder Herbert Lux, patented in 1981: 'The Original' – a support element with a core of expanded polystyrene hard foam (EPS) and double-sided mortar coating in which a stabilising glass fibre fabric is embedded.

Starting from the construction panel in different thicknesses, the range has been constantly developed and expanded. Today, LUX ELEMENTS offers complete systems for **bathroom and shower, private spa and wellness.**



# LUX ELEMENTS® – The original

On account of its outstanding physical properties in combination with very good workability, this moisture-resistant and modern building material creates free space for planners, designers, tradesmen and industry – whether in the form of panels, blanks or ready-made products.

Hard foam support elements from LUX ELEMENTS are characterised by these advantages:

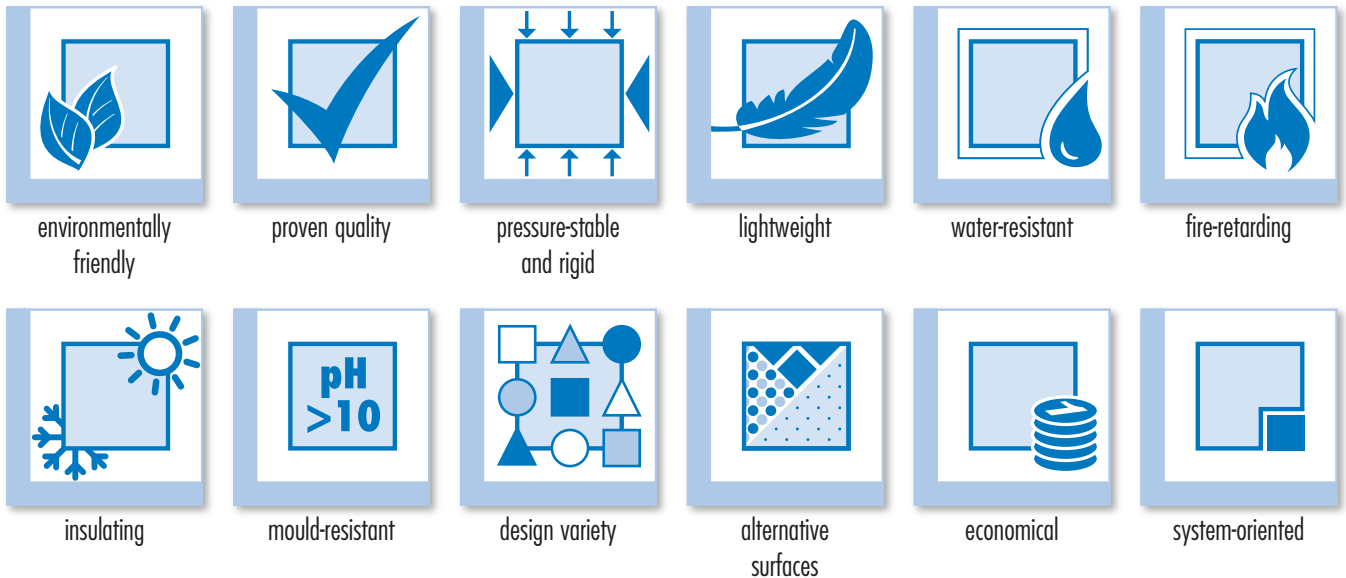

Detailed information on the material properties can be found in the brochure '**Sustainability – The Original can do**'  
(Download from [www.luxelements.com](http://www.luxelements.com) under *Downloads/Information brochure*)

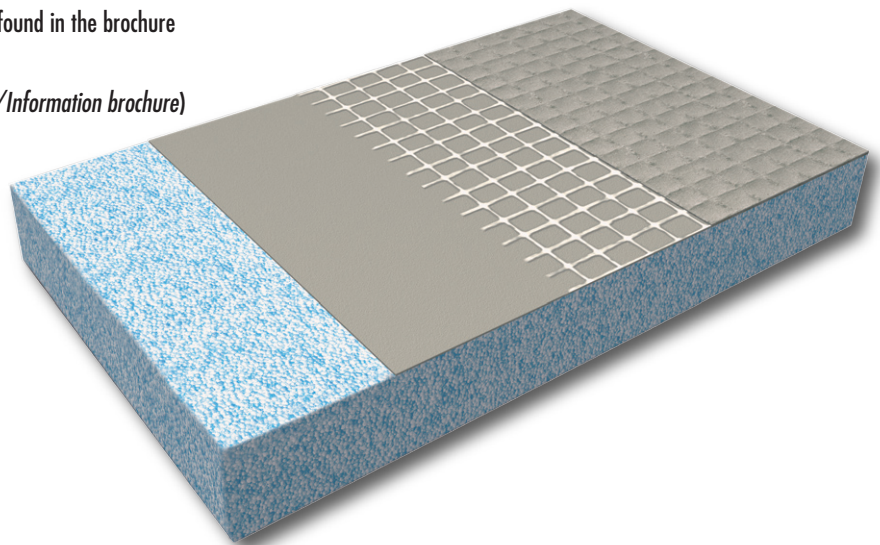

# LUX ELEMENTS – Competence and experience

Based on LUX ELEMENTS' decades of experience in spa complex construction, the LUX ELEMENTS®-SPA system was developed for the private sector. With these products, spa projects can be realised in which relaxation in an intimate atmosphere is in demand.

LUX ELEMENTS offers:

- High quality through the checking of all production stages in our own factory
- Many years of experience in the international public and private spa market
- Standard products for bathrooms and spa areas
- Extendable systems and flexible solutions for every room situation



The LUX ELEMENTS®-SPA system offers

- Freely selectable technical components for different purposes of use
- Planning security through fast approval processes and short delivery times
- Optimal conditions for construction in existing buildings due to adaptability to local conditions
- Individual design through surface design with tiles, plaster or stopping



# LUX ELEMENTS – Online

## Digital configurator

A digital configurator assists you in the **planning** of a LUX ELEMENTS®-SPA product. The application takes into account all technical specifications and lists all options.

Here's how it works:

- Press the "Configure now" button on the website [www.luxelements-privatespa.com](http://www.luxelements-privatespa.com)
- Begin with the data entry without registration and select the basic shape and size
- The application now guides you step-by-step through the complete configuration

At the end, you receive a summary of your individual planning in the form of an article list as the basis for ordering. **Simple, fast and secure.**

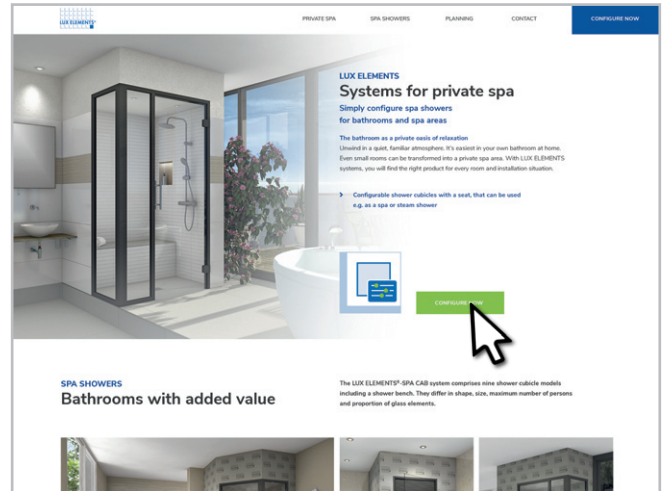

[www.luxelements-privatespa.com](http://www.luxelements-privatespa.com)

# LUX ELEMENTS – Systems for private spa

## Spa showers

Variety for every situation – people's wishes differ just as much as rooms. The **LUX ELEMENTS®-SPA CAB** system is suitable for every installation situation. It allows you to choose the basic shape, dimensions, equipment and technology.

- Various basic shapes for one to two persons
- Individual placement: free-standing, in front of the wall, in a corner of the room or a niche
- Adaptable to the room situation through stepless extension
- Free choice of technical components
- Various usage possibilities: also usable as a steam bath with a steam generator
- Individual design with tiles, plaster or stopping as desired



# Content

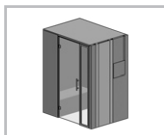

## Spa showers

Spa showers LUX ELEMENTS®-SPA CAB .....	8
Shower base set CAB-BP .....	16
Overview of cabin models .....	18
Pentagonal basic shape, without glass front – CAB-F 1400 .....	20
Pentagonal basic shape, with glass front – CAB-F-GF 1400 .....	22
Square basic shape, without glass front – CAB-Q 1400 .....	24
Square basic shape, with glass front – CAB-Q-GF 1400 .....	26
Rectangular basic shape, without glass front – CAB-R 1780/950 .....	28
Rectangular basic shape, with glass front – CAB-R-GF 1780/950 .....	30
Rectangular basic shape, without glass front – CAB-R 1780/1250 .....	32
Rectangular basic shape, with glass front – CAB-R-GF 1780/1250 .....	34
Rectangular basic shape, with two benches – CAB-R 2000/950 .....	36
Panel – CAB-DA B .....	38
Inclined roof element – CAB-DA MONO .....	40
Light – CAB-LI .....	42
Sound – CAB-SO KSW .....	44
Heating – CAB-HE E BA .....	46
Steam – CAB-TE DE .....	48
Technical panel – CAB-TE TPA .....	50
Maintenance opening – CAB-TE REV 300 .....	52
Floor drain supports and accessories – TUB .....	54
Mounting accessories – CAB-KIT / COL-AK .....	56

## Spa showers

### LUX ELEMENTS®-SPA CAB

- Spa shower as construction kit
- Nine models in three basic shapes: pentagonal, square or rectangular
- Floor-to-ceiling block frame with glass door incl. handle, door version DIN left or right
- Partly with wall elements made of glass, framed in classy metal profiles
- Integrated installation wall for accepting pipes/cables, fittings or other technical components
- Including bench seat, also with heating
- Including practical and decorative niche, also with LED light strip



Spa shower as construction kit in three basic shapes

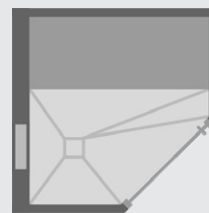

pentagonal – CAB-F

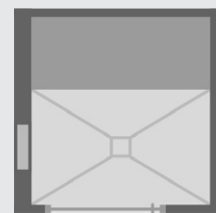

square – CAB-Q



rectangular (1x bench seat) – CAB-R



rectangular (2x bench seat) – CAB-R

### Individual extension – CAB E (optional)

All cabin models can be extended steplessly by up to 300 mm on one or both sides. The components made of glass and metal remain unchanged. Adaptation to the desired size is done exclusively by enlarging components made of hard foam support material.

Individual extension

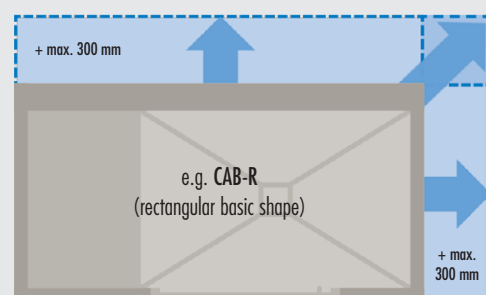



CAB – the construction

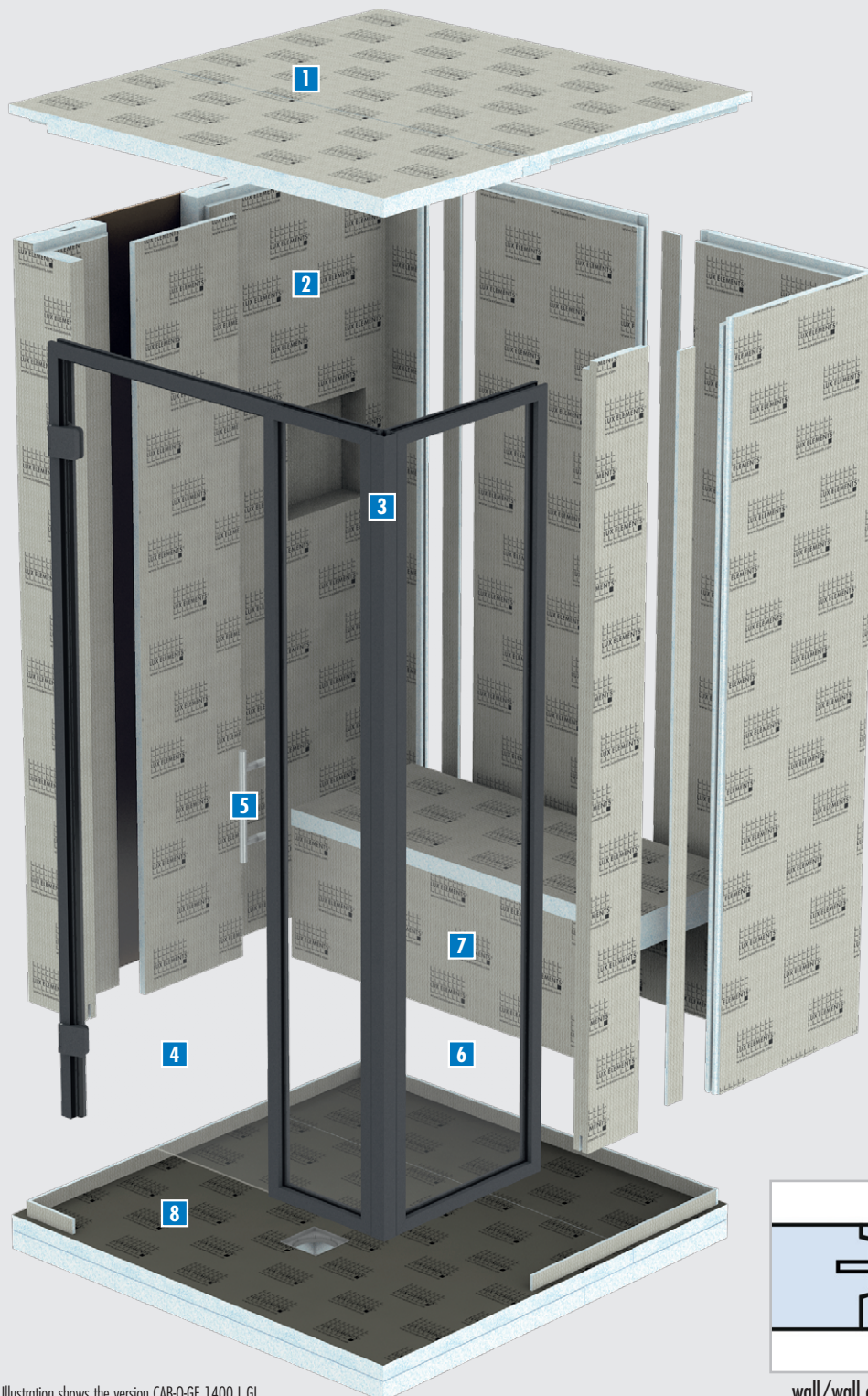

- 1** Roof with step-seam (see page 10)
- 2** Wall construction (as kit) stable connection due to V-milling and tongue-and-groove principle (see page 12)
- 3** Metal profiles floor to ceiling, dark grey metallic DB703 (see page 14)
- 4** Door made of 8 mm safety glass (see page 14)
- 5** Handle stainless steel, matt brushed (see page 14)
- 6** Glass wall elements (depending on model) made of 8 mm safety glass (see page 14)
- 7** Bench seat interior can be used for technical equipment or pipe/cable laying, optionally with heating (see page 11)
- 8** Shower base set (optional) with point drainage (see page 16)

Illustration shows the version CAB-Q-GF 1400 L.G.I.

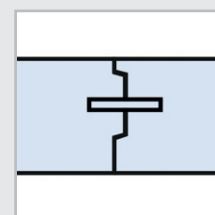

wall/wall connection

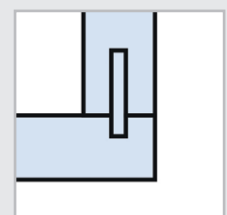

wall/floor connection

## LUX ELEMENTS

### Roof (standard)

- Roof shape **FLAT** (flat roof), 2-piece, 50 mm thick
- Total construction height (without floor): 2200 mm
- Simple assembly due to step-seam and millings
- For cabin use as a shower
- Optional: hard foam support element as a panel from the roof to the ceiling **CAB-DA B** (see page 38)
- Optional: LED built-in spotlights **CAB-LI P-WW-2** (see page 42)

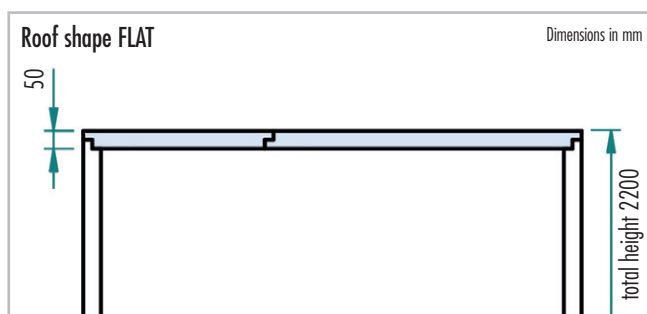
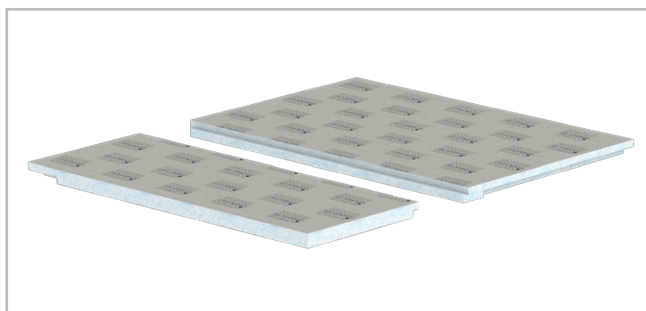

### Roof (alternative)

- Roof shape **MONO**, inclined roof element
- Total construction height (without floor): 2250 mm
- For cabin use as a steam shower (see page 40)



**Bench seat**

- Height 450 mm, depth 500 mm
- 3-part
- Interior hollow for pipe/cable laying or installation of technical components
- Optional: technical panel for the installation of technical components **CAB-TE TPA** (see page 50)
- Optional: maintenance opening **CAB-TE REV 300** (see page 52)

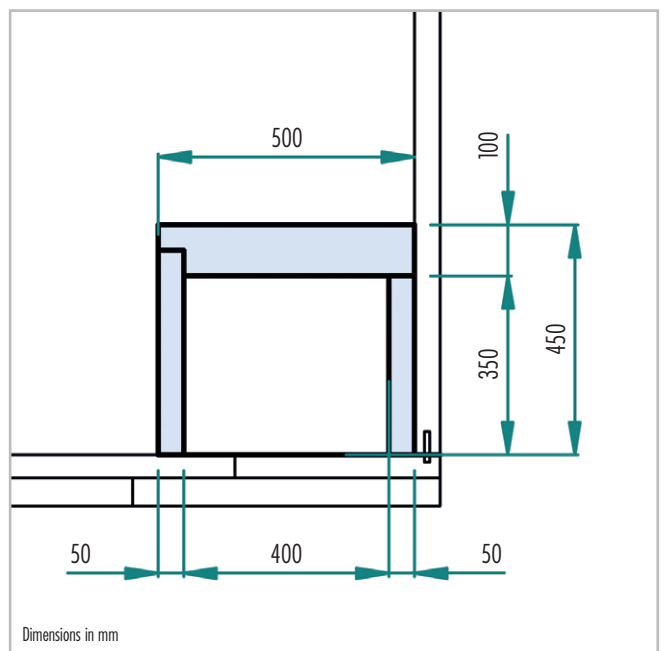
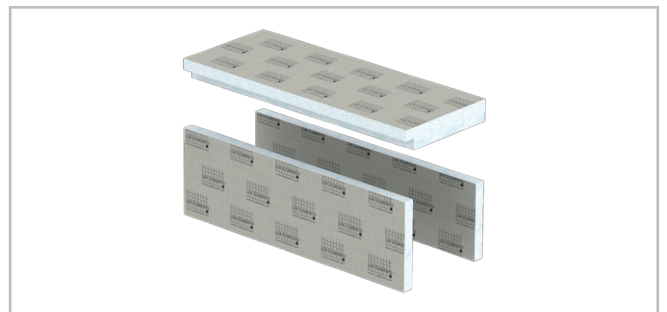

## Wall elements with installation panel and niche element

- Wall construction as kit
- Wall thickness 50 mm, installation wall 100 mm thick
- Installation wall with factory-integrated mounting plate
- Niche element with factory milling for cable routing
- Stable, self-levelling connection of the wall elements due to V-milling and tongue-and-groove principle

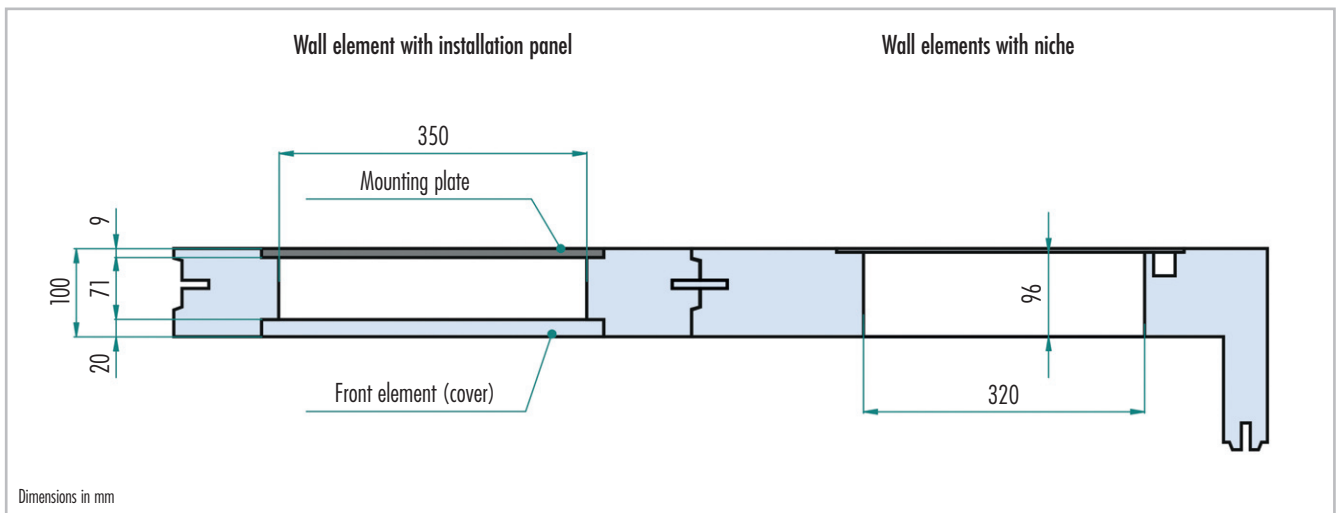

### Installation panel

- Prefabricated element for accepting pipes/cables, fittings and other technical components
- Front cover made of hard foam support material
- Factory-integrated into wall element (predefined position, depending on model)
- Optional: steam inlet plate **CAB-TE DE** for use as a steam shower (see page 48)

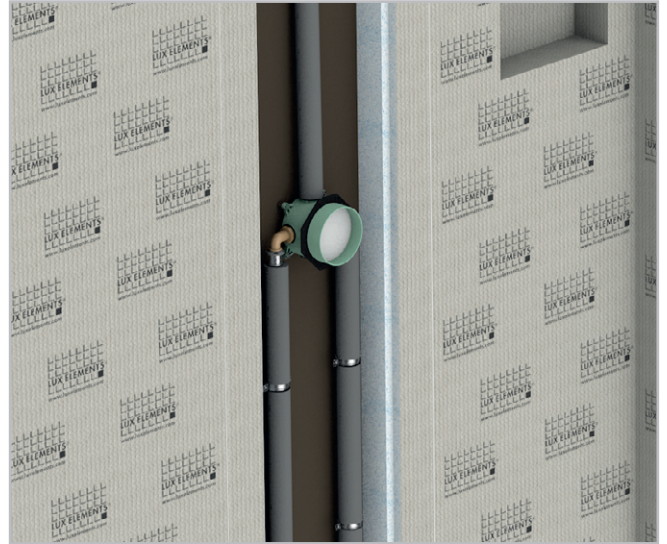

### Niche

- Niche 320 x 320 mm, depth 96 mm
- Factory-integrated into wall element (predefined position)
- Optional: niche lighting **CAB-LI L-VW NI** (see page 42)



## Glass profile constructions

- Powder-coated in dark grey metallic DB703
- Block frame, 2150 x 800 mm
- Wall profile(s), 2150 mm high
- Glass door and glass wall made of 8 mm ESG\*, defined width, not extendable
- Door stop DIN left or right
- Wall element made of 8 mm ESG\*, fixed dimensions, non-extendable

\* ESG = tempered safety glass

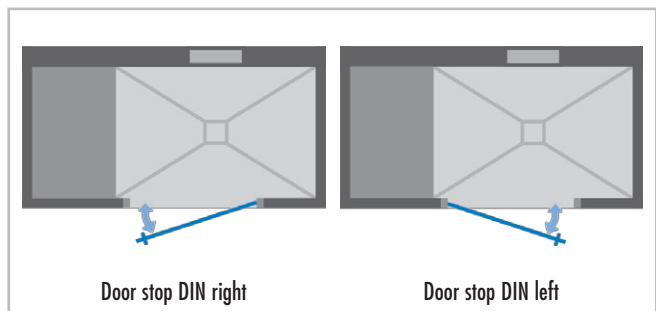

Fixed components of the glass profile construction:

- Stainless steel handle, matt brushed
- Door hinges, dark grey metallic DB703
- Special angle connectors

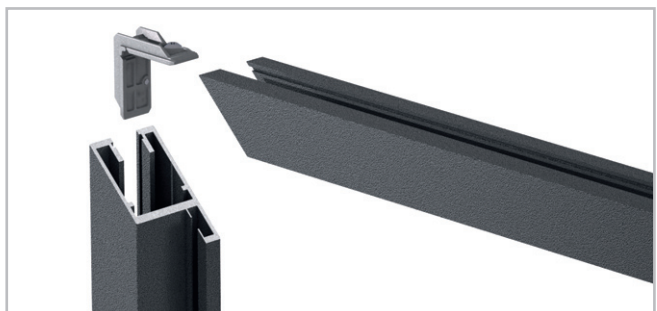

Only with glass wall elements:

- Frame fastening
- Floor holding bracket

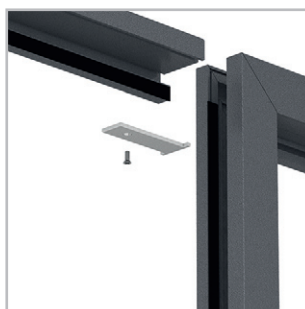

Design variants (depending on cabin type) with details of the connections



block frame door

1 / 2

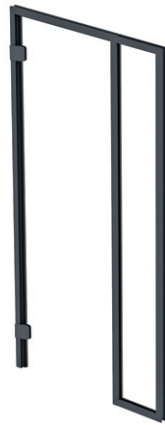

block frame + wall profile

1 / 2 / 3 / 4



block frame + wall profiles  
with corner connection 90°

1 / 2 / 3 / 4 / 5

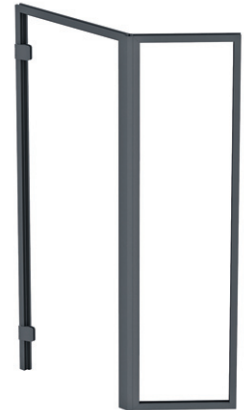

block frame + wall profile  
with corner connection 135°

1 / 2 / 3 / 4 / 6

Frame profiles

Dimensions in mm

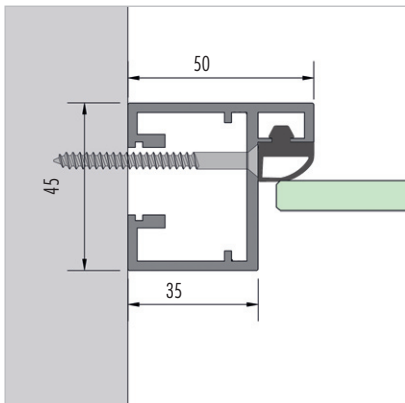

1 frame profile, wall connection

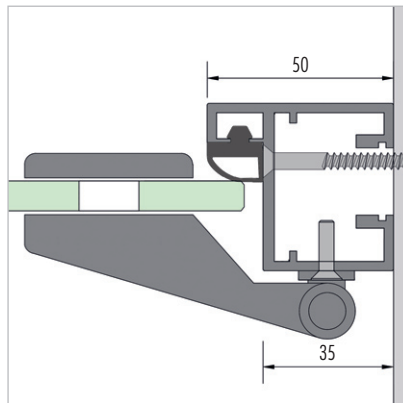

2 frame profile door hinge, wall connection

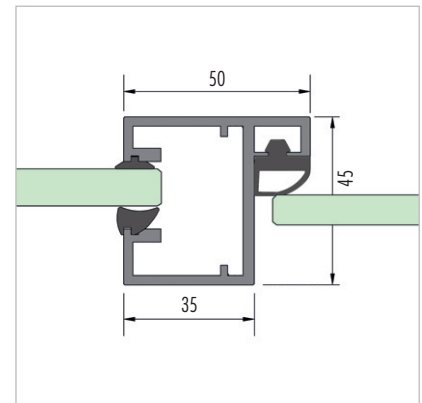

3 frame profile, connection wall profile

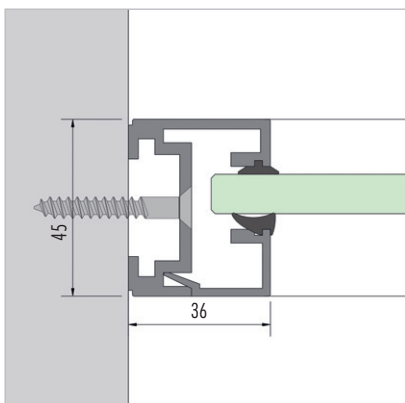

4 wall profile, wall connection

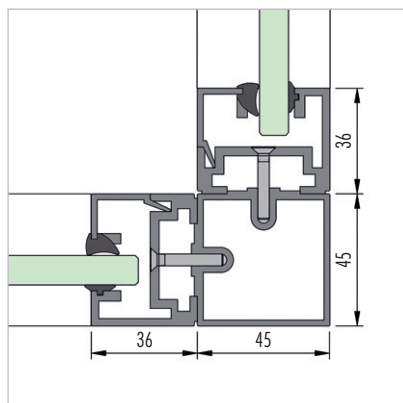

5 2x wall profile with corner profile 90°

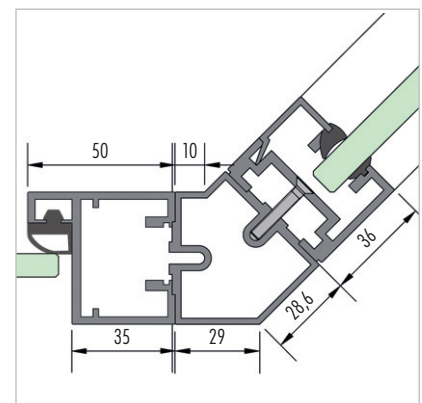

6 frame profile with corner profile 135° + wall profile

**Shower base set**

**CAB-BP**

- For every cabin model
- Consisting of multi-part shower base element and multi-part substrate element, horizontal floor drain support and hair trap

**Shower base element**

- Height: 30/45 mm, factory sealed
- Built-in and sealed floor drain fitting frame
- Shower area with prefabricated four-sided slope, bench and wall area without slope
- Base construction with circumferential milling and tongue for simple wall mounting
- Secure click system for fastening the drain connection fitting

**Substrate element**

- Height: 55 mm
- Simple and fast height compensation
- Suitable for integrating the drainage technology

**Floor drain support**

- DN 50 horizontal
- With odour trap
- Drainage capacity (with standard grate): 1,0 l/s (in accordance with DIN EN 1253 [l/s])

**Hair trap**

- Reliably traps hair and dirt and thus prevents blockages in the drain pipe
- Removable

**Extension (optional)**

- Individual, stepless extension of the shower base element and substrate element CAB-BP E
- Suitable for the extended cabin (see page 8)

**Accessories (optional)**

- Various grate variants with grate fitting frame as well as other accessories see page 54

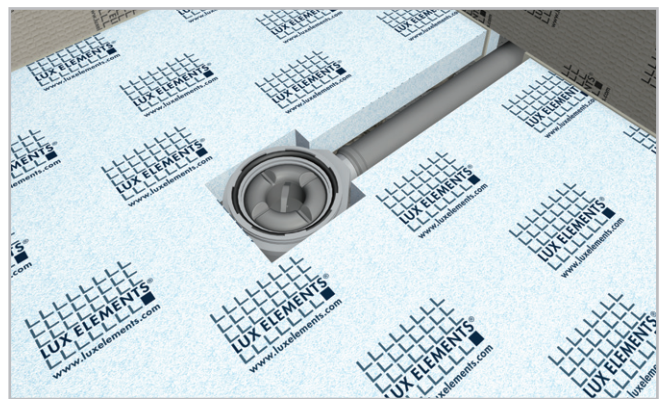
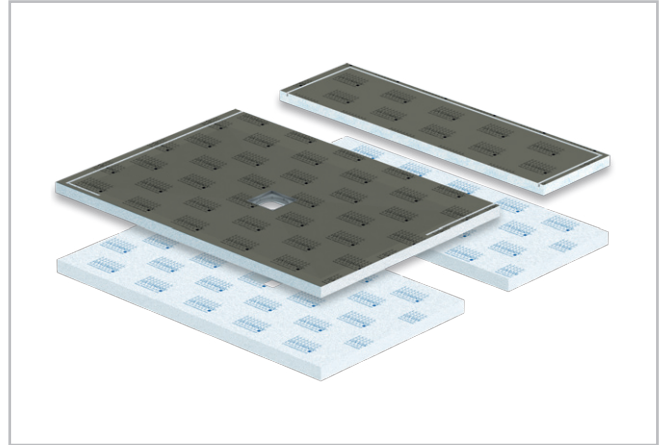



Shower base set CAB-BP

**LUX ELEMENTS®-SPA CAB-BP shower bases**  
 Standard-compliant sealing for highly stressed areas according to DIN 18534, Part 6

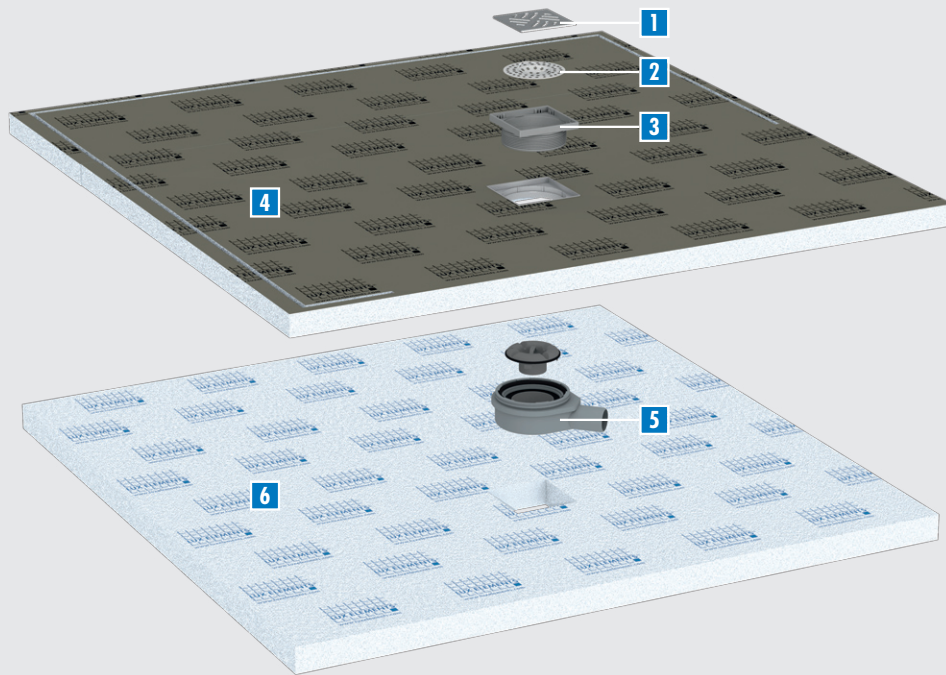

- 1** Grate  
standard- or design grate  
(see page 54)
- 2** Hair trap  
removable
- 3** Grate fitting frame  
universal height adjustment to the  
covering thickness (see page 54)
- 4** Shower base element  
factory-sealed with built-in and  
sealed floor drain fitting frame
- 5** Floor drain support  
DN 50 horizontal
- 6** Substrate element  
simple and fast height  
compensation

**Installation height**

The height of the shower base is 30/45 mm (gradient in the shower area), the substrate element is 55 mm high.

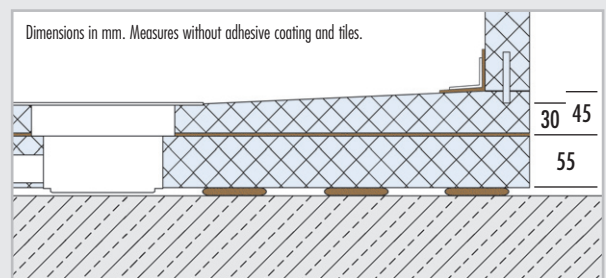

**Secondary drainage**

All LUX ELEMENTS®-SPA CAB-BP shower base elements are equipped with a second drainage level.

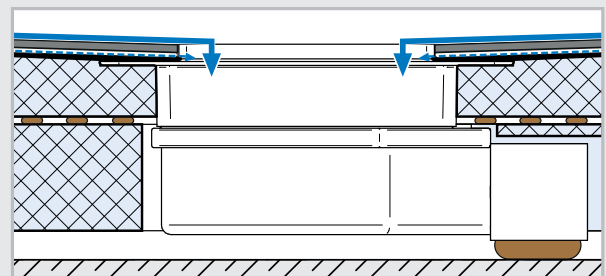

**LUX ELEMENTS®-SPA CAB** – Overview of cabin models

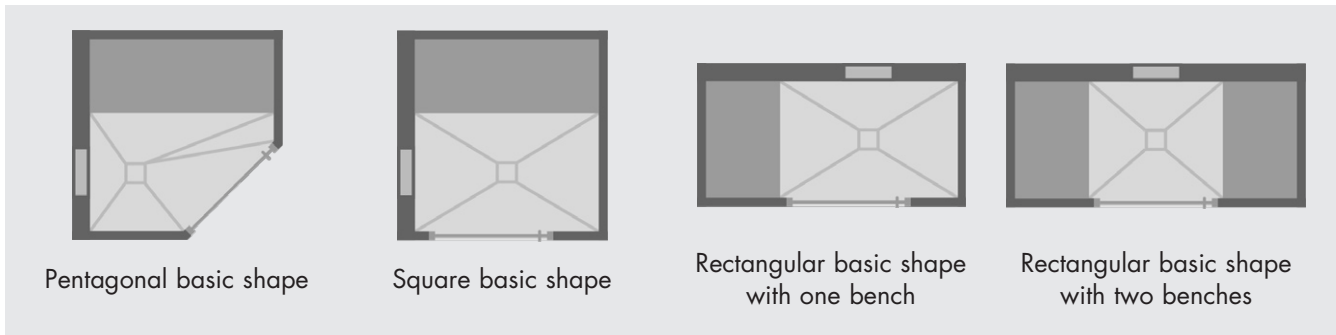

**Pentagonal basic shape – CAB-F**

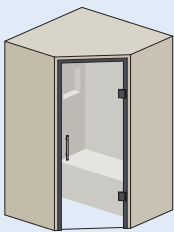

without glass front  
**CAB-F 1400**

see page 20

- Cabin size (floor area): 1400 x 1400 mm
- Max. extendable to: 1700 x 1700 mm
- Four different design variants

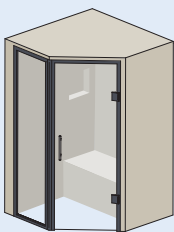

with glass front  
**CAB-F-GF 1400**

see page 22

- Cabin size (floor area): 1400 x 1400 mm
- Max. extendable to: 1700 x 1700 mm
- Two different design variants



**Square basic shape – CAB-Q**

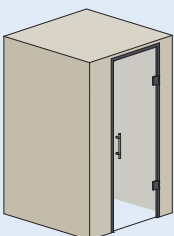

without glass front  
**CAB-Q 1400**

see page 24

- Cabin size (floor area): 1400 x 1400 mm
- Max. extendable to: 1700 x 1700 mm
- Four different design variants

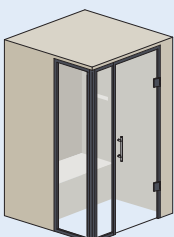

with glass front  
**CAB-Q-GF 1400**

see page 26

- Cabin size (floor area): 1400 x 1400 mm
- Max. extendable to: 1700 x 1700 mm
- Two different design variants



**Rectangular basic shape – CAB-R**

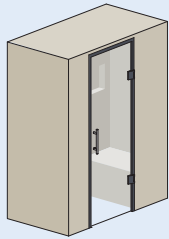

without glass front  
**CAB-R 1780/950**

see page 28

- Cabin size (floor area): 1780 x 950 mm
- Max. extendable to: 2080 x 1250 mm
- Four different design variants

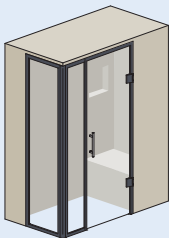

with glass front  
**CAB-R-GF 1780/950**

see page 30

- Cabin size (floor area): 1780 x 950 mm
- Max. extendable to: 2080 x 1250 mm
- Two different design variants

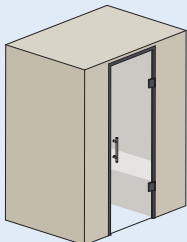

without glass front  
**CAB-R 1780/1250**

see page 32

- Cabin size (floor area): 1780 x 1250 mm
- Max. extendable to: 2080 x 1550 mm
- Four different design variants

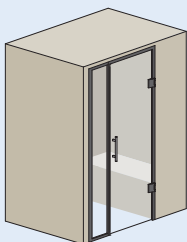

with glass front  
**CAB-R-GF 1780/1250**

see page 34

- Cabin size (floor area): 1780 x 1250 mm
- Max. extendable to: 2080 x 1550 mm
- Two different design variants

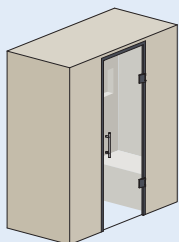

without glass front with two benches  
**CAB-R 2000/950**

see page 36

- Cabin size (floor area): 2000 x 950 mm
- Max. extendable to: 2300 x 1250 mm
- Two different design variants



Optional accessories

from page 38

for cabin, drain and mounting

**Pentagonal basic shape, without glass front**  
**CAB-F 1400**

- Spa shower for one to two persons
- Floor area 1400 x 1400 mm, wall thickness 50 mm, roof shape FLAT (total height 2200 mm)
- Stepless extension by a maximum of 300 mm possible on one or both sides
- With installation wall (100 mm thick) left or right of the door, incl. installation panel and niche
- Glass profile construction (2150 mm high): block frame, glass door incl. handle (door version DIN left or right)
- Bench seat with cavity for pipe/cable laying (arrangement to the left or right of the door)



**Accessories (optional)**

- Shower base set: shower base and substrate element, horizontal drain and hair trap (see page 16)
- Additional accessories from page 38: Panel / Inclined roof element / Light / Sound / Heating / Steam / Technical panel / Maintenance opening / Floor drain supports and accessories / Mounting accessories

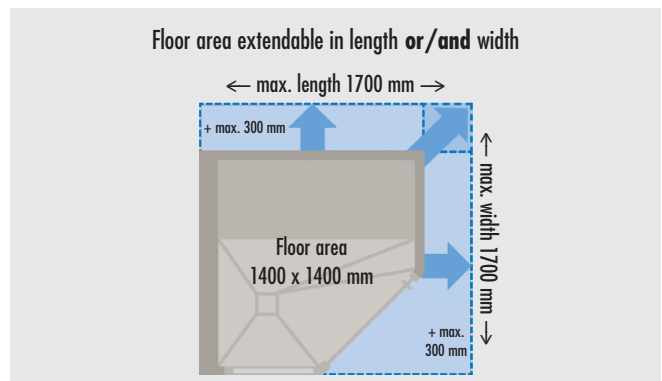

**CAB-F 1400**

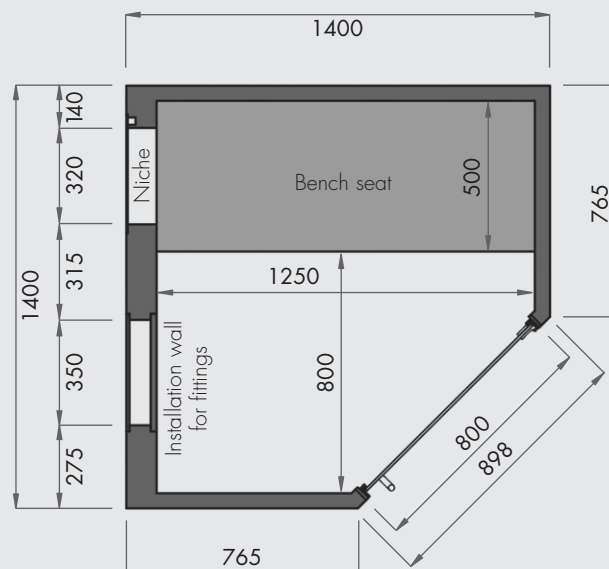

Dimensions in mm

(Illustration shows the version 'R.RL')

■ PRODUCT SPECIFICATIONS – LUX ELEMENTS®-SPA CAB-F 1400 ...

Packaging specifications on request

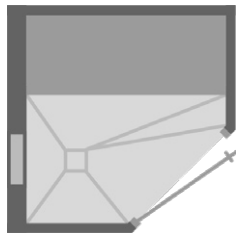
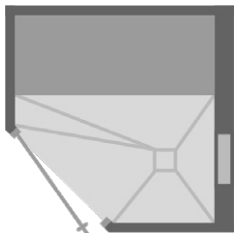
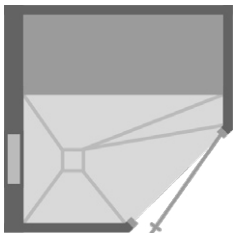
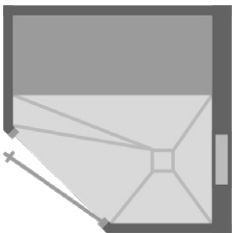
ARTICLE-NUMBER	ARTICLE-NAME / ARTICLE-DESCRIPTION	UNIT	PRICE / UNIT €
	<b>CAB-F 1400 L.RL *</b> door DIN <u>left</u> / bench seat <u>right</u> of the door / installation wall <u>left</u> of the door		
	<b>CAB-F 1400 L.LR *</b> door DIN <u>left</u> / bench seat <u>left</u> of the door / installation wall <u>right</u> of the door		
	<b>CAB-F 1400 R.RL *</b> door DIN <u>right</u> / bench seat <u>right</u> of the door / installation wall <u>left</u> of the door		
	<b>CAB-F 1400 R.LR *</b> door DIN <u>right</u> / bench seat <u>left</u> of the door / installation wall <u>right</u> of the door		

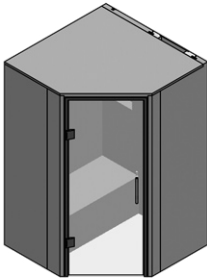
Spa shower			
 <i>(Illustration shows the version 'L.LR')</i>	<b>CAB-F 1400 ...</b> , pentagonal spa shower as kit, 1400 x 1400 x 2200 mm, wall thickness 50 mm, one wall 100 mm thick as installation wall (arrangement <b>left</b> or <b>right</b> of the door), incl. installation panel and niche 320 x 320 mm, roof shape FLAT, floor-to-ceiling glass profile construction 800 x 2150 mm, powder-coated dark grey metallic DB 703, door version DIN <b>left</b> or <b>right</b> , with glass door incl. handle, bench seat with cavity for pipe/cable laying (arrangement <b>left</b> or <b>right</b> of the door) <b>optional: CAB-E...</b> , infinitely variable extension of the spa shower by a maximum of 300 mm in length <b>or/and</b> width, max. length 1700 mm, max. width 1700 mm		
	<b>LESPA1000</b>	<b>CAB-F 1400 L.RL</b> , glass profile construction door version DIN <b>left</b> , bench seat <b>right</b> of the door, installation wall <b>left</b> of the door	set 5.216,65
	<b>LESPA1001</b>	<b>CAB-F 1400 L.LR</b> , glass profile construction door version DIN <b>left</b> , bench seat <b>left</b> of the door, installation wall <b>right</b> of the door	set 5.216,65
	<b>LESPA1002</b>	<b>CAB-F 1400 R.RL</b> , glass profile construction door version DIN <b>right</b> , bench seat <b>right</b> of the door, installation wall <b>left</b> of the door	set 5.216,65
	<b>LESPA1003</b>	<b>CAB-F 1400 R.LR</b> , glass profile construction door version DIN <b>right</b> , bench seat <b>left</b> of the door, installation wall <b>right</b> of the door	set 5.216,65
	<b>LESPA1200</b>	<b>CAB-E-1</b> , infinitely variable extension of the spa shower by a maximum of 300 mm in length <b>or</b> width	surcharge 320,00
	<b>LESPA1201</b>	<b>CAB-E-2</b> , infinitely variable extension of the spa shower by a maximum of 300 mm in length <b>and</b> width	surcharge 462,00

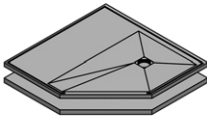
Shower base			
 <i>(Illustration shows the version 'LR')</i>	<b>CAB-BP-F 1400 ...</b> , shower base set consisting of multi-part shower base element 1400 x 1400 x 30/45 mm with built-in and sealed floor drain fitting frame 135 x 135 mm, multi-part substrate element 1400 x 1400 x 55 mm, floor drain support DN 50 horizontal incl. odour trap and hair trap <b>optional: CAB-BP E...</b> , infinitely variable extension of the shower base set by a maximum of 300 mm in length <b>or/and</b> width, max. length 1700 mm, max. width 1700 mm		
	<b>LESPA1100</b>	<b>CAB-BP-F 1400 LR</b> , for CAB-F 1400 R.LR or L.LR	set 833,52
	<b>LESPA1101</b>	<b>CAB-BP-F 1400 RL</b> , for CAB-F 1400 R.RL or L.RL	set 833,52
	<b>LESPA1203</b>	<b>CAB-BP E-1</b> , infinitely variable extension of the shower base set by a maximum of 300 mm in length <b>or</b> width	surcharge 179,90
	<b>LESPA1204</b>	<b>CAB-BP E-2</b> , infinitely variable extension of the shower base set by a maximum of 300 mm in length <b>and</b> width	surcharge 318,90

Further accessories from page 38 / Floor drain supports and accessories see page 54 / Mounting accessories see page 56

\* Illustration incl. base

 Cabin configurator and technical documentation to download, see [www.luxelements-privatespa.com](http://www.luxelements-privatespa.com)

Pentagonal basic shape, with glass front  
**CAB-F-GF 1400**

- Spa shower for one to two persons
- Floor area 1400 x 1400 mm, wall thickness 50 mm, roof shape FLAT (total height 2200 mm)
- Stepless extension by a maximum of 300 mm possible on one or both sides
- With installation wall (100 mm thick) left or right of the door, incl. installation panel and niche
- Glass profile construction (2150 mm high) with 135°-corner: block frame, glass door incl. handle (door version DIN left or right), wall profile, glass wall
- Bench seat with cavity for pipe/cable laying (arrangement to the left or right of the door)



(Illustration incl. panel)

Accessories (optional)

- Shower base set: shower base and substrate element, horizontal drain and hair trap (see page 16)
- Additional accessories from page 38: Panel / Inclined roof element / Light / Sound / Heating / Steam / Technical panel / Maintenance opening / Floor drain supports and accessories / Mounting accessories

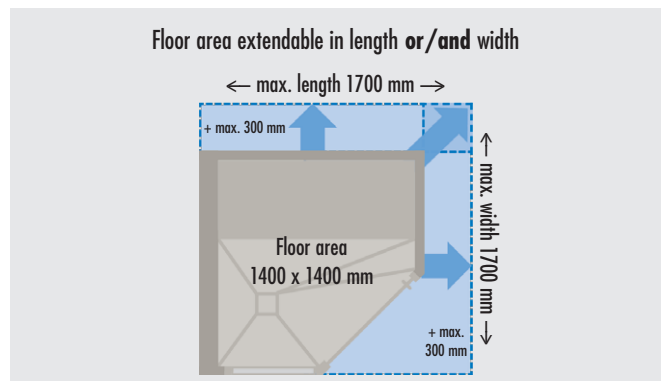

CAB-F-GF 1400

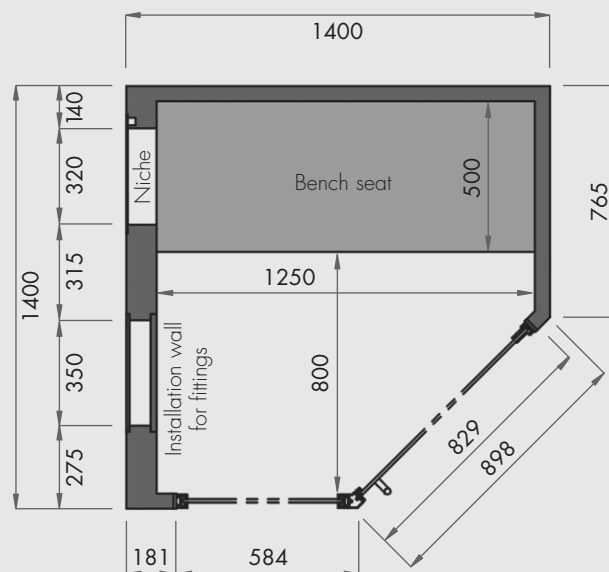

Dimensions in mm

(Illustration shows the version 'R.RL')

## ■ PRODUCT SPECIFICATIONS – LUX ELEMENTS®-SPA CAB-F-GF 1400 ...

Packaging specifications on request

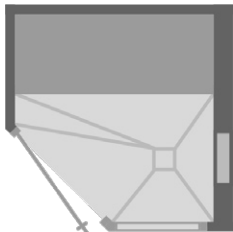
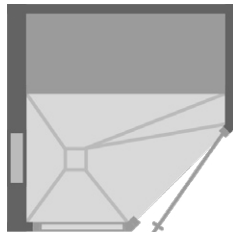
ARTICLE-NUMBER	ARTICLE-NAME / ARTICLE-DESCRIPTION	UNIT	PRICE / UNIT €
	 <p><b>CAB-F-GF 1400 L.LR *</b> door DIN <u>left</u> / bench seat <u>left</u> of the door / installation wall <u>right</u> of the door</p>		
	 <p><b>CAB-F-GF 1400 R.RL *</b> door DIN <u>right</u> / bench seat <u>right</u> of the door / installation wall <u>left</u> of the door</p>		

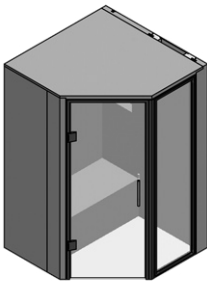
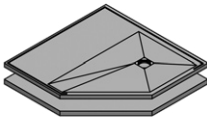
Spa shower				
 <p>(Illustration shows the version 'L.LR')</p>	<p><b>CAB-F-GF 1400 ...</b>, pentagonal spa shower with glass front as kit, 1400 x 1400 x 2200 mm, wall thickness 50 mm, one wall 100 mm thick as installation wall (arrangement <b>left</b> or <b>right</b> of the door), incl. installation panel and niche 320 x 320 mm, roof shape FLAT, floor-to-ceiling glass profile construction with 135 °-corner 829 + 584 x 2150 mm, powder-coated dark grey metallic DB 703, door version DIN <b>left</b> or <b>right</b>, with glass door incl. handle, bench seat with cavity for pipe/cable laying (arrangement <b>left</b> or <b>right</b> of the door)  <b>optional: CAB-E...</b>, infinitely variable extension of the spa shower by a maximum of 300 mm in length <b>or/and</b> width, max. length 1700 mm, max. width 1700 mm</p>			
	<b>LESPA1004</b>	<b>CAB-F-GF 1400 L.LR</b> , glass profile construction door version DIN <b>left</b> , bench seat <b>left</b> of the door, installation wall <b>right</b> of the door	set	6.817,13
	<b>LESPA1005</b>	<b>CAB-F-GF 1400 R.RL</b> , glass profile construction door version DIN <b>right</b> , bench seat <b>right</b> of the door, installation wall <b>left</b> of the door	set	6.817,13
	<b>LESPA1200</b>	<b>CAB-E-1</b> , infinitely variable extension of the spa shower by a maximum of 300 mm in length <b>or</b> width	surcharge	320,00
	<b>LESPA1201</b>	<b>CAB-E-2</b> , infinitely variable extension of the spa shower by a maximum of 300 mm in length <b>and</b> width	surcharge	462,00
Shower base				
 <p>(Illustration shows the version 'LR')</p>	<p><b>CAB-BP-F-GF 1400 ...</b>, shower base set consisting of multi-part shower base element 1400 x 1400 x 30/45 mm with built-in and sealed floor drain fitting frame 135 x 135 mm, multi-part substrate element 1400 x 1400 x 55 mm, floor drain support DN 50 horizontal incl. odour trap and hair trap  <b>optional: CAB-BP E...</b>, infinitely variable extension of the shower base set by a maximum of 300 mm in length <b>or/and</b> width, max. length 1700 mm, max. width 1700 mm</p>			
	<b>LESPA1102</b>	<b>CAB-BP-F-GF 1400 LR</b> , for CAB-F-GF 1400 L.LR	set	858,10
	<b>LESPA1103</b>	<b>CAB-BP-F-GF 1400 RL</b> , for CAB-F-GF 1400 R.RL	set	858,10
	<b>LESPA1203</b>	<b>CAB-BP E-1</b> , infinitely variable extension of the shower base set by a maximum of 300 mm in length <b>or</b> width	surcharge	179,90
	<b>LESPA1204</b>	<b>CAB-BP E-2</b> , infinitely variable extension of the shower base set by a maximum of 300 mm in length <b>and</b> width	surcharge	318,90

Further accessories from page 38 / Floor drain supports and accessories see page 54 / Mounting accessories see page 56

\* Illustration incl. base

 Cabin configurator and technical documentation to download, see  
[www.luxelements-privatespa.com](http://www.luxelements-privatespa.com)

Square basic shape, without glass front  
**CAB-Q 1400**

- Spa shower for one to two persons
- Floor area 1400 x 1400 mm, wall thickness 50 mm, roof shape FLAT (total height 2200 mm)
- Stepless extension by a maximum of 300 mm possible on one or both sides
- With installation wall (100 mm thick) left or right of the door, incl. installation panel and niche
- Glass profile construction (2150 mm high): block frame, glass door incl. handle (door version DIN left or right)
- Bench seat with cavity for pipe/cable laying (arrangement to the left or right of the door)



(Illustration incl. panel)

Accessories (optional)

- Shower base set: shower base and substrate element, horizontal drain and hair trap (see page 16)
- Additional accessories from page 38: Panel / Inclined roof element / Light / Sound / Heating / Steam / Technical panel / Maintenance opening / Floor drain supports and accessories / Mounting accessories

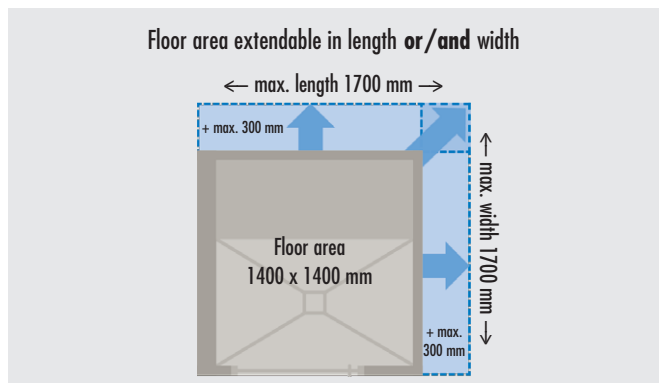

CAB-Q 1400

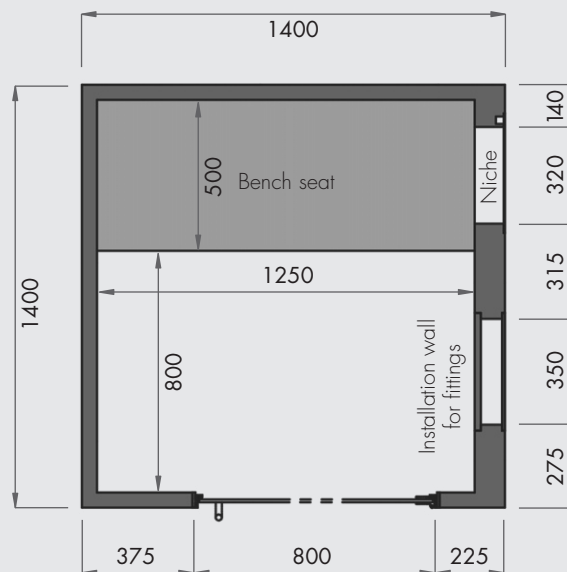

Dimensions in mm

(Illustration shows the version 'R.GR')



■ PRODUCT SPECIFICATIONS – LUX ELEMENTS®-SPA CAB-Q 1400 ...

Packaging specifications on request

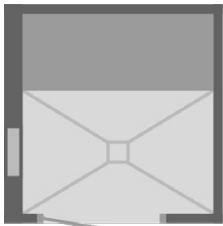
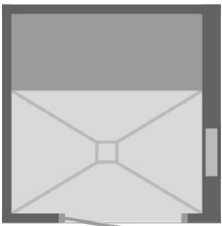
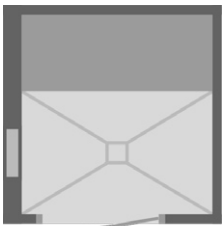
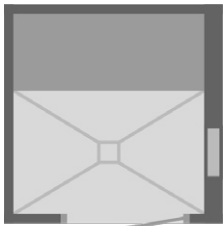
ARTICLE-NUMBER	ARTICLE-NAME / ARTICLE-DESCRIPTION	UNIT	PRICE / UNIT €
	<b>CAB-Q 1400 L.GL *</b> door DIN <u>left</u> / bench seat opposite the door / installation wall <u>left</u> of the door		
	<b>CAB-Q 1400 L.GR *</b> door DIN <u>left</u> / bench seat opposite the door / installation wall <u>right</u> of the door		
	<b>CAB-Q 1400 R.GL *</b> door DIN <u>right</u> / bench seat opposite the door / installation wall <u>left</u> of the door		
	<b>CAB-Q 1400 R.GR *</b> door DIN <u>right</u> / bench seat opposite the door / installation wall <u>right</u> of the door		

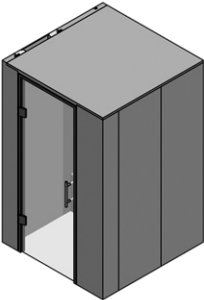
Spa shower			
	<b>CAB-Q 1400 ...</b> , square spa shower as kit, 1400 x 1400 x 2200 mm, wall thickness 50 mm, one wall 100 mm thick as installation wall (arrangement <u>left</u> or <u>right</u> of the door), incl. installation panel and niche 320 x 320 mm, roof shape FLAT, floor-to-ceiling glass profile construction 800 x 2150 mm, powder-coated dark grey metallic DB 703, door version DIN <u>left</u> or <u>right</u> , with glass door incl. handle, bench seat with cavity for pipe/cable laying (arrangement opposite the door) <b>optional: CAB-E...</b> , infinitely variable extension of the spa shower by a maximum of 300 mm in length <b>or/and</b> width, max. length 1700 mm, max. width 1700 mm		
	<b>LESPA1006</b>	<b>CAB-Q 1400 L.GL</b> , glass profile construction door version DIN <u>left</u> , installation wall <u>left</u> of the door	set 5.281,91
	<b>LESPA1007</b>	<b>CAB-Q 1400 L.GR</b> , glass profile construction door version DIN <u>left</u> , installation wall <u>right</u> of the door	set 5.281,91
	<b>LESPA1008</b>	<b>CAB-Q 1400 R.GL</b> , glass profile construction door version DIN <u>right</u> , installation wall <u>left</u> of the door	set 5.281,91
	<b>LESPA1009</b>	<b>CAB-Q 1400 R.GR</b> , glass profile construction door version DIN <u>right</u> , installation wall <u>right</u> of the door	set 5.281,91
	<b>LESPA1200</b>	<b>CAB-E-1</b> , infinitely variable extension of the spa shower by a maximum of 300 mm in length <b>or</b> width	surcharge 320,00
	<b>LESPA1201</b>	<b>CAB-E-2</b> , infinitely variable extension of the spa shower by a maximum of 300 mm in length <b>and</b> width	surcharge 462,00

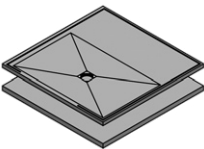
Shower base			
	<b>CAB-BP-Q 1400 ...</b> , shower base set consisting of multi-part shower base element 1400 x 1400 x 30/45 mm with built-in and sealed floor drain fitting frame 135 x 135 mm, multi-part substrate element 1400 x 1400 x 55 mm, floor drain support DN 50 horizontal incl. odour trap and hair trap <b>optional: CAB-BP E...</b> , infinitely variable extension of the shower base set by a maximum of 300 mm in length <b>or/and</b> width, max. length 1700 mm, max. width 1700 mm		
	<b>LESPA1104</b>	<b>CAB-BP-Q 1400 GL</b> , for CAB-Q 1400 L.GL or R.GL	set 904,69
	<b>LESPA1105</b>	<b>CAB-BP-Q 1400 GR</b> , for CAB-Q 1400 L.GR or R.GR	set 904,69
	<b>LESPA1203</b>	<b>CAB-BP E-1</b> , infinitely variable extension of the shower base set by a maximum of 300 mm in length <b>or</b> width	surcharge 179,90
	<b>LESPA1204</b>	<b>CAB-BP E-2</b> , infinitely variable extension of the shower base set by a maximum of 300 mm in length <b>and</b> width	surcharge 318,90

Further accessories from page 38 / Floor drain supports and accessories see page 54 / Mounting accessories see page 56

\* Illustration incl. base

 Cabin configurator and technical documentation to download, see [www.luxelements-privatespa.com](http://www.luxelements-privatespa.com)

## Square basic shape, with glass front **CAB-Q-GF 1400**

- Spa shower for one to two persons
- Floor area 1400 x 1400 mm, wall thickness 50 mm, roof shape FLAT (total height 2200 mm)
- Stepless extension by a maximum of 300 mm possible on one or both sides
- With installation wall (100 mm thick) left or right of the door, incl. installation panel and niche
- Glass profile construction (2150 mm high), with 90°-corner: block frame, glass door incl. handle (door version DIN left or right), wall profiles, glass walls
- Bench seat with cavity for pipe/cable laying (arrangement to the left or right of the door)



### Accessories (optional)

- Shower base set: shower base and substrate element, horizontal drain and hair trap (see page 16)
- Additional accessories from page 38: Panel / Inclined roof element / Light / Sound / Heating / Steam / Technical panel / Maintenance opening / Floor drain supports and accessories / Mounting accessories

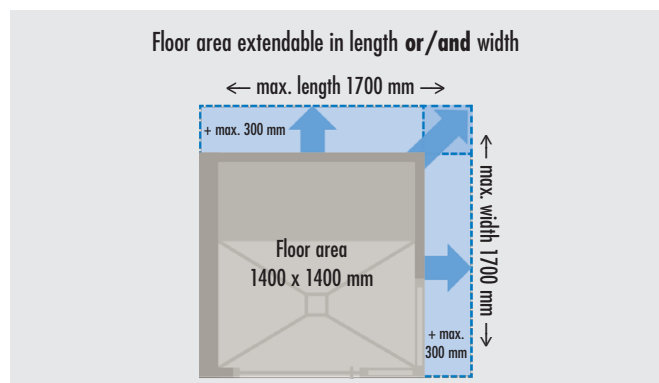

### CAB-Q-GF 1400

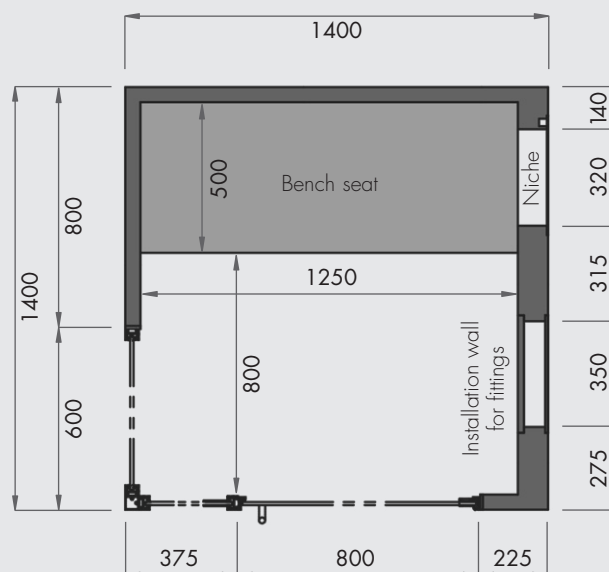



Dimensions in mm

(Illustration shows the version 'R.GR')

■ PRODUCT SPECIFICATIONS – LUX ELEMENTS®-SPA CAB-Q-GF 1400 ...

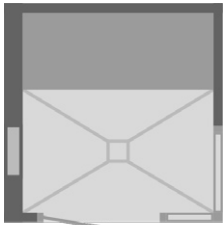
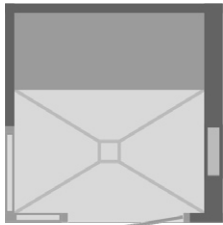
Packaging specifications on request

ARTICLE-NUMBER	ARTICLE-NAME / ARTICLE-DESCRIPTION	UNIT	PRICE / UNIT €
			
<p><b>CAB-Q-GF 1400 L.GL *</b> door DIN <u>left</u> / bench seat opposite the door / installation wall <u>left</u> of the door</p>			
			
<p><b>CAB-Q-GF 1400 R.GR *</b> door DIN <u>right</u> / bench seat opposite the door / installation wall <u>right</u> of the door</p>			

Spa shower				
 <p>(Illustration shows the version 'L.GL')</p>	<p><b>CAB-Q-GF 1400 ...</b>, square spa shower with glass front as kit, 1400 x 1400 x 2200 mm, wall thickness 50 mm, one wall 100 mm thick as installation wall (arrangement <b>left</b> or <b>right</b> of the door), incl. installation panel and niche 320 x 320 mm, roof shape FLAT, floor-to-ceiling glass profile construction with 90 °-corner 1175 + 600 x 2150 mm, powder-coated dark grey metallic DB 703, door version DIN <b>left</b> or <b>right</b>, with glass door incl. handle, bench seat with cavity for pipe/cable laying (arrangement opposite the door)  <b>optional: CAB-E...</b>, infinitely variable extension of the spa shower by a maximum of 300 mm in length <b>or/and</b> width, max. length 1700 mm, max. width 1700 mm</p>			
	<b>LESPA1010</b>	<b>CAB-Q-GF 1400 L.GL</b> , glass profile construction door version DIN <b>left</b> , installation wall <b>left</b> of the door	set	6.953,88
	<b>LESPA1011</b>	<b>CAB-Q-GF 1400 R.GR</b> , glass profile construction door version DIN <b>right</b> , installation wall <b>right</b> of the door	set	6.953,88
	<b>LESPA1200</b>	<b>CAB-E-1</b> , infinitely variable extension of the spa shower by a maximum of 300 mm in length <b>or</b> width	surcharge	320,00
	<b>LESPA1201</b>	<b>CAB-E-2</b> , infinitely variable extension of the spa shower by a maximum of 300 mm in length <b>and</b> width	surcharge	462,00

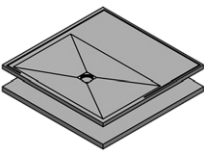
Shower base				
 <p>(Illustration shows the version 'GL')</p>	<p><b>CAB-BP-Q-GF 1400 ...</b>, shower base set consisting of multi-part shower base element 1400 x 1400 x 30/45 mm with built-in and sealed floor drain fitting frame 135 x 135 mm, multi-part substrate element 1400 x 1400 x 55 mm, floor drain support DN 50 horizontal incl. odour trap and hair trap  <b>optional: CAB-BP E...</b>, infinitely variable extension of the shower base set by a maximum of 300 mm in length <b>or/and</b> width, max. length 1700 mm, max. width 1700 mm</p>			
	<b>LESPA1106</b>	<b>CAB-BP-Q-GF 1400 GL</b> , for CAB-Q-GF 1400 L.GL	set	944,63
	<b>LESPA1107</b>	<b>CAB-BP-Q-GF 1400 GR</b> , for CAB-Q-GF 1400 R.GR	set	944,63
	<b>LESPA1203</b>	<b>CAB-BP E-1</b> , infinitely variable extension of the shower base set by a maximum of 300 mm in length <b>or</b> width	surcharge	179,90
	<b>LESPA1204</b>	<b>CAB-BP E-2</b> , infinitely variable extension of the shower base set by a maximum of 300 mm in length <b>and</b> width	surcharge	318,90

Further accessories from page 38 / Floor drain supports and accessories see page 54 / Mounting accessories see page 56

\* Illustration incl. base

 Cabin configurator and technical documentation to download, see [www.luxelements-privatespa.com](http://www.luxelements-privatespa.com)

Rectangular basic shape, without glass front  
**CAB-R 1780/950**

- Spa shower for one person
- Floor area 1780 x 950 mm, wall thickness 50 mm, roof shape FLAT (total height 2200 mm)
- Stepless extension by a maximum of 300 mm possible on one or both sides
- With installation wall (100 mm thick) opposite the door, incl. installation panel and niche
- Glass profile construction (2150 mm high): block frame, glass door incl. handle (door version DIN left or right)
- Bench seat with cavity for pipe/cable laying (arrangement to the left or right of the door)



(Illustration incl. panel)

Accessories (optional)

- Shower base set: shower base and substrate element, horizontal drain and hair trap (see page 16)
- Additional accessories from page 38: Panel / Inclined roof element / light / Sound / Heating / Steam / Technical panel / Maintenance opening / Floor drain supports and accessories / Mounting accessories

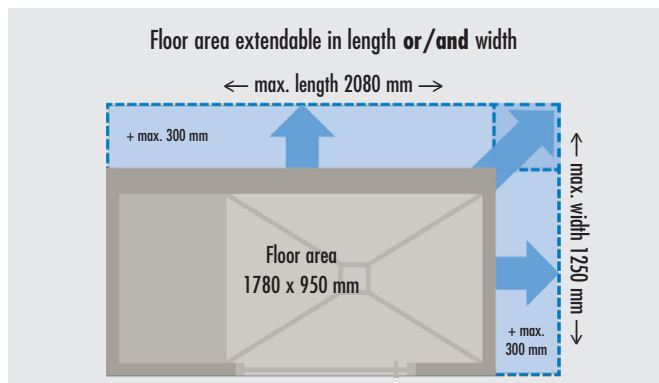

CAB-R 1780/950

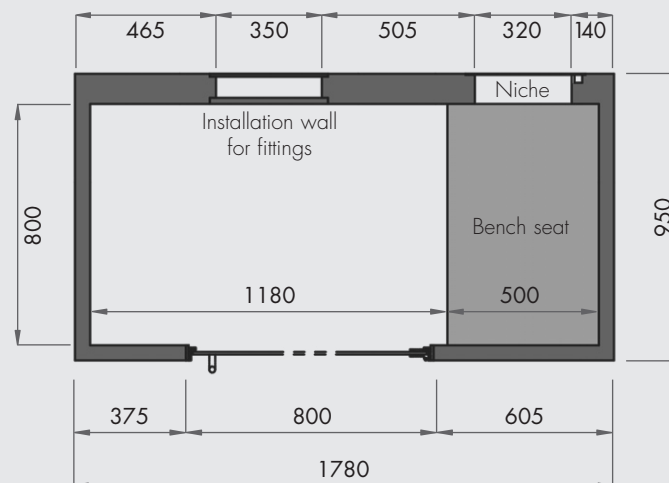

Dimensions in mm

(Illustration shows the version 'R.RG')

■ PRODUCT SPECIFICATIONS – LUX ELEMENTS®-SPA CAB-R 1780/950 ...

Packaging specifications on request

ARTICLE-NUMBER	ARTICLE-NAME / ARTICLE-DESCRIPTION	UNIT	PRICE / UNIT €
----------------	------------------------------------	------	----------------



**CAB-R 1780/950 L.LG \***  
door DIN left / bench seat left of the door / installation wall opposite the door



**CAB-R 1780/950 L.RG \***  
door DIN left / bench seat right of the door / installation wall opposite the door



**CAB-R 1780/950 R.LG \***  
door DIN right / bench seat left of the door / installation wall opposite the door



**CAB-R 1780/950 R.RG \***  
door DIN right / bench seat right of the door / installation wall opposite the door

**Spa shower**

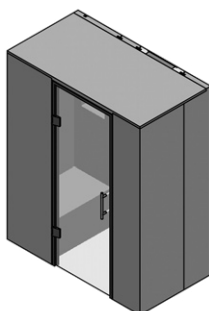

(Illustration shows the version 'L.LG')

**CAB-R 1780/950 ...**, rectangular spa shower as kit, 1780 x 950 x 2200 mm, wall thickness 50 mm, one wall 100 mm thick as installation wall (arrangement opposite the door), incl. installation panel and niche 320 x 320 mm, roof shape FLAT, floor-to-ceiling glass profile construction 800 x 2150 mm, powder-coated dark grey metallic DB 703, door version DIN **left** or **right**, with glass door incl. handle, bench seat with cavity for pipe/cable laying (arrangement **left** or **right** of the door)

**optional: CAB-E...**, infinitely variable extension of the spa shower by a maximum of 300 mm in length **or/and** width, max. length 2080 mm, max. width 1250 mm

<b>LESPA1012</b>	<b>CAB-R 1780/950 L.LG</b> , glass profile construction door version DIN <b>left</b> , bench seat <b>left</b> of the door	set	4.952,68
<b>LESPA1013</b>	<b>CAB-R 1780/950 L.RG</b> , glass profile construction door version DIN <b>left</b> , bench seat <b>right</b> of the door	set	4.952,68
<b>LESPA1014</b>	<b>CAB-R 1780/950 R.LG</b> , glass profile construction door version DIN <b>right</b> , bench seat <b>left</b> of the door	set	4.952,68
<b>LESPA1015</b>	<b>CAB-R 1780/950 R.RG</b> , glass profile construction door version DIN <b>right</b> , bench seat <b>right</b> of the door	set	4.952,68
<b>LESPA1200</b>	<b>CAB-E-1</b> , infinitely variable extension of the spa shower by a maximum of 300 mm in length <b>or</b> width	surcharge	320,00
<b>LESPA1201</b>	<b>CAB-E-2</b> , infinitely variable extension of the spa shower by a maximum of 300 mm in length <b>and</b> width	surcharge	462,00

**Shower base**

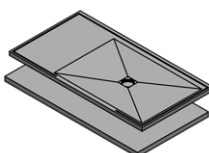

(Illustration shows the version 'LG')

**CAB-BP-R 1780/950 ...**, shower base set consisting of multi-part shower base element 1780 x 950 x 30/45 mm with built-in and sealed floor drain fitting frame 135 x 135 mm, multi-part substrate element 1780 x 950 x 55 mm, floor drain support DN 50 horizontal incl. odour trap and hair trap

**optional: CAB-BP E...**, infinitely variable extension of the shower base set by a maximum of 300 mm in length **or/and** width, max. length 2080 mm, max. width 1250 mm

<b>LESPA1108</b>	<b>CAB-BP-R 1780/950 LG</b> , for CAB-R 1780/950 L.LG or R.LG	set	809,73
<b>LESPA1109</b>	<b>CAB-BP-R 1780/950 RG</b> , for CAB-R 1780/950 L.RG or R.RG	set	809,73
<b>LESPA1203</b>	<b>CAB-BP E-1</b> , infinitely variable extension of the shower base set by a maximum of 300 mm in length <b>or</b> width	surcharge	179,90
<b>LESPA1204</b>	<b>CAB-BP E-2</b> , infinitely variable extension of the shower base set by a maximum of 300 mm in length <b>and</b> width	surcharge	318,90

Further accessories from page 38 / Floor drain supports and accessories see page 54 / Mounting accessories see page 56

\* Illustration incl. base

 Cabin configurator and technical documentation to download, see [www.luxelements-privatespa.com](http://www.luxelements-privatespa.com)

Rectangular basic shape, with glass front  
**CAB-R-GF 1780/950**

- Spa shower for one person
- Floor area 1780 x 950 mm, wall thickness 50 mm, roof shape FLAT (total height 2200 mm)
- Stepless extension by a maximum of 300 mm possible on one or both sides
- With installation wall (100 mm thick) opposite the door, incl. installation panel and niche
- Glass profile construction (2150 mm high), with 90°-corner: block frame, glass door incl. handle (door version DIN left or right), wall profiles, glass walls
- Bench seat with cavity for pipe/cable laying (arrangement to the left or right of the door)

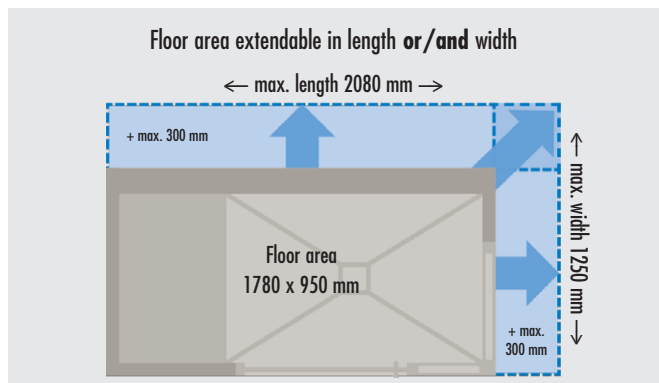

Accessories (optional)

- Shower base set: shower base and substrate element, horizontal drain and hair trap (see page 16)
- Additional accessories from page 38: Panel / Inclined roof element / Light / Sound / Heating / Steam / Technical panel / Maintenance opening / Floor drain supports and accessories / Mounting accessories

CAB-R-GF 1780/950

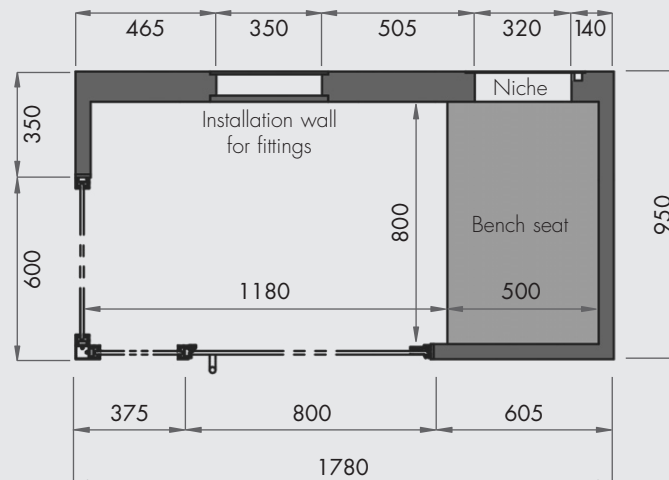

Dimensions in mm

(Illustration shows the version 'R.RG')

## ■ PRODUCT SPECIFICATIONS – LUX ELEMENTS®-SPA CAB-R-GF 1780/950 ...

Packaging specifications on request

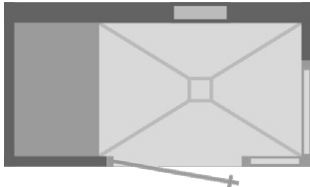
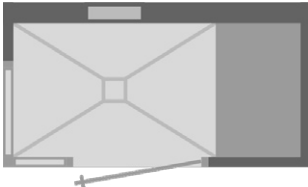
ARTICLE-NUMBER	ARTICLE-NAME / ARTICLE-DESCRIPTION	UNIT	PRICE / UNIT €
			
	<b>CAB-R-GF 1780/950 L.LG*</b> door DIN <u>left</u> / bench seat <u>left</u> of the door / installation wall opposite the door		
			
	<b>CAB-R-GF 1780/950 R.RG*</b> door DIN <u>right</u> / bench seat <u>right</u> of the door / installation wall opposite the door		

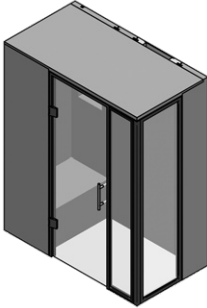
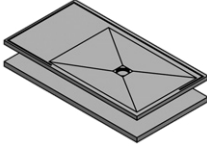
Spa shower				
 <p>(Illustration shows the version 'L.LG')</p>	<p><b>CAB-R-GF 1780/950 ...</b>, rectangular spa shower with glass front as kit, 1780 x 950 x 2200 mm, wall thickness 50 mm, one wall 100 mm thick as installation wall (arrangement opposite the door), incl. installation panel and niche 320 x 320 mm, roof shape FLAT, floor-to-ceiling glass profile construction with 90°-corner 1175 + 600 x 2150 mm, powder-coated dark grey metallic DB 703, door version DIN <u>left</u> or <u>right</u>, with glass door incl. handle, bench seat with cavity for pipe/cable laying (arrangement <u>left</u> or <u>right</u> of the door)</p> <p><u>optional</u>: <b>CAB-E...</b>, infinitely variable extension of the spa shower by a maximum of 300 mm in length <u>or/and</u> width, max. length 2080 mm, max. width 1250 mm</p>			
	<b>LESPA1016</b>	<b>CAB-R-GF 1780/950 L.LG</b> , glass profile construction door version DIN <u>left</u> , bench seat <u>left</u> of the door	set	6.588,71
	<b>LESPA1017</b>	<b>CAB-R-GF 1780/950 R.RG</b> , glass profile construction door version DIN <u>right</u> , bench seat <u>right</u> of the door	set	6.588,71
	<b>LESPA1200</b>	<b>CAB-E-1</b> , infinitely variable extension of the spa shower by a maximum of 300 mm in length <u>or</u> width	surcharge	320,00
	<b>LESPA1201</b>	<b>CAB-E-2</b> , infinitely variable extension of the spa shower by a maximum of 300 mm in length <u>and</u> width	surcharge	462,00
Shower base				
 <p>(Illustration shows the version 'L.G')</p>	<p><b>CAB-BP-R-GF 1780/950 ...</b>, shower base set consisting of multi-part shower base element 1780 x 950 x 30/45 mm with built-in and sealed floor drain fitting frame 135 x 135 mm, multi-part substrate element 1780 x 950 x 55 mm, floor drain support DN 50 horizontal incl. odour trap and hair trap</p> <p><u>optional</u>: <b>CAB-BP E...</b>, infinitely variable extension of the shower base set by a maximum of 300 mm in length <u>or/and</u> width, max. length 2080 mm, max. width 1250 mm</p>			
	<b>LESPA1110</b>	<b>CAB-BP-R-GF 1780/950 LG</b> , for CAB-R-GF 1780/950 L.LG	set	849,67
	<b>LESPA1111</b>	<b>CAB-BP-R-GF 1780/950 RG</b> , for CAB-R-GF 1780/950 R.RG	set	849,67
	<b>LESPA1203</b>	<b>CAB-BP E-1</b> , infinitely variable extension of the shower base set by a maximum of 300 mm in length <u>or</u> width	surcharge	179,90
	<b>LESPA1204</b>	<b>CAB-BP E-2</b> , infinitely variable extension of the shower base set by a maximum of 300 mm in length <u>and</u> width	surcharge	318,90

Further accessories from page 38 / Floor drain supports and accessories see page 54 / Mounting accessories see page 56

\* Illustration incl. base

 Cabin configurator and technical documentation to download, see [www.luxelements-privatespa.com](http://www.luxelements-privatespa.com)

Rectangular basic shape, without glass front  
**CAB-R 1780/1250**

- Spa shower for one to two persons
- Floor area 1780 x 1250 mm, wall thickness 50 mm, roof shape FLAT (total height 2200 mm)
- Stepless extension by a maximum of 300 mm possible on one or both sides
- With installation wall (100 mm thick) left or right of the door, incl. installation panel and niche
- Glass profile construction (2150 mm high): block frame, glass door incl. handle (door version DIN left or right)
- Bench seat with cavity for pipe/cable laying (arrangement to the left or right of the door)



(Illustration incl. panel)

Accessories (optional)

- Shower base set: shower base and substrate element, horizontal drain and hair trap (see page 16)
- Additional accessories from page 38: Panel / Inclined roof element / Light / Sound / Heating / Steam / Technical panel / Maintenance opening / Floor drain supports and accessories / Mounting accessories

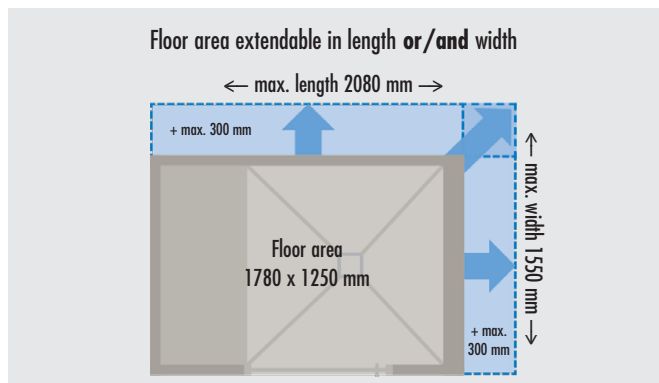

CAB-R 1780/1250

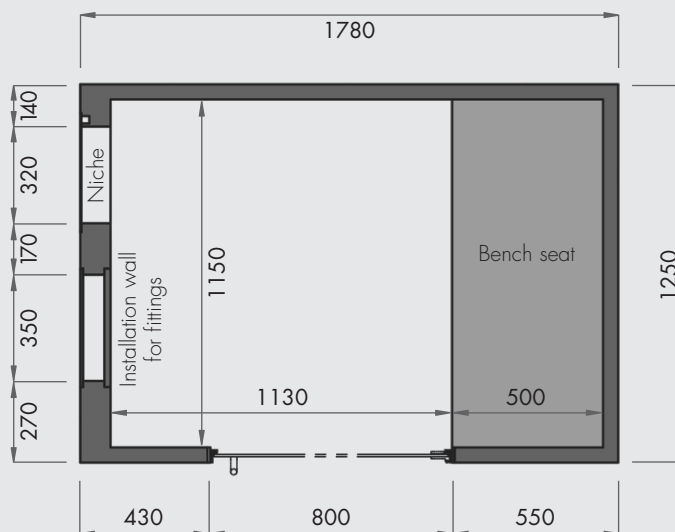

Dimensions in mm

(Illustration shows the version 'R.RL')



## ■ PRODUCT SPECIFICATIONS – LUX ELEMENTS®-SPA CAB-R 1780/1250 ...

Packaging specifications on request

ARTICLE-NUMBER	ARTICLE-NAME / ARTICLE-DESCRIPTION	UNIT	PRICE / UNIT €
----------------	------------------------------------	------	----------------

<b>CAB-R 1780/1250 L.LR *</b> door DIN <u>left</u> / bench seat <u>left</u> of the door / installation wall <u>right</u> of the door	<b>CAB-R 1780/1250 L.RL *</b> door DIN <u>left</u> / bench seat <u>right</u> of the door / installation wall <u>left</u> of the door	<b>CAB-R 1780/1250 R.LR *</b> door DIN <u>right</u> / bench seat <u>left</u> of the door / installation wall <u>right</u> of the door	<b>CAB-R 1780/1250 R.RL *</b> door DIN <u>right</u> / bench seat <u>right</u> of the door / installation wall <u>left</u> of the door

Spa shower					
	<b>CAB-R 1780/1250 ...</b> , rectangular spa shower as kit, 1780 x 1250 x 2200 mm, wall thickness 50 mm, one wall 100 mm thick as installation wall (arrangement <b>left</b> or <b>right</b> of the door), incl. installation panel and niche 320 x 320 mm, roof shape FLAT, floor-to-ceiling glass profile construction 800 x 2150 mm, powder-coated dark grey metallic DB 703, door version DIN <b>left</b> or <b>right</b> , with glass door incl. handle, bench seat with cavity for pipe/cable laying (arrangement <b>left</b> or <b>right</b> of the door) <b>optional: CAB-E...</b> , infinitely variable extension of the spa shower by a maximum of 300 mm in length <b>or/and</b> width, max. length 2080 mm, max. width 1550 mm				
	<b>LESPA1018</b>	<b>CAB-R 1780/1250 L.LR</b> , glass profile construction door version DIN <b>left</b> , bench seat <b>left</b> of the door, installation wall <b>right</b> of the door	set	5.211,91	
	<b>LESPA1019</b>	<b>CAB-R 1780/1250 L.RL</b> , glass profile construction door version DIN <b>left</b> , bench seat <b>right</b> of the door, installation wall <b>left</b> of the door	set	5.211,91	
	<b>LESPA1020</b>	<b>CAB-R 1780/1250 R.LR</b> , glass profile construction door version DIN <b>right</b> , bench seat <b>left</b> of the door, installation wall <b>right</b> of the door	set	5.211,91	
	<b>LESPA1021</b>	<b>CAB-R 1780/1250 R.RL</b> , glass profile construction door version DIN <b>right</b> , bench seat <b>right</b> of the door, installation wall <b>left</b> of the door	set	5.211,91	
	<b>LESPA1200</b>	<b>CAB-E-1</b> , infinitely variable extension of the spa shower by a maximum of 300 mm in length <b>or</b> width	surcharge	320,00	
	<b>LESPA1201</b>	<b>CAB-E-2</b> , infinitely variable extension of the spa shower by a maximum of 300 mm in length <b>and</b> width	surcharge	462,00	

Shower base				
	<b>CAB-BP-R 1780/1250</b> , shower base set consisting of multi-part shower base element 1780 x 1250 x 30/45 mm with built-in and sealed floor drain fitting frame 135 x 135 mm, multi-part substrate element 1780 x 1250 x 55 mm, floor drain support DN 50 horizontal incl. odour trap and hair trap <b>optional: CAB-BP E...</b> , infinitely variable extension of the shower base set by a maximum of 300 mm in length <b>or/and</b> width, max. length 2080 mm, max. width 1550 mm			
	<b>LESPA1112</b>	<b>CAB-BP-R 1780/1250 LR</b> , for CAB-R 1780/1250 L.LR or R.LR	set	1.003,17
	<b>LESPA1113</b>	<b>CAB-BP-R 1780/1250 RL</b> , for CAB-R 1780/1250 L.RL or R.RL	set	1.003,17
	<b>LESPA1203</b>	<b>CAB-BP E-1</b> , infinitely variable extension of the shower base set by a maximum of 300 mm in length <b>or</b> width	surcharge	179,90
	<b>LESPA1204</b>	<b>CAB-BP E-2</b> , infinitely variable extension of the shower base set by a maximum of 300 mm in length <b>and</b> width	surcharge	318,90

Further accessories from page 38 / Floor drain supports and accessories see page 54 / Mounting accessories see page 56

\* Illustration incl. base

 Cabin configurator and technical documentation to download, see [www.luxelements-privatespa.com](http://www.luxelements-privatespa.com)

Rectangular basic shape, with glass front  
**CAB-R-GF 1780/1250**

- Spa shower for one to two persons
- Floor area 1780 x 1250 mm, wall thickness 50 mm, roof shape FLAT (total height 2200 mm)
- Stepless extension by a maximum of 300 mm possible on one or both sides
- With installation wall (100 mm thick) left or right of the door, incl. installation panel and niche
- Glass profile construction (2150 mm high): block frame, glass door incl. handle (door version DIN left or right), wall profile, glass wall
- Bench seat with cavity for pipe/cable laying (arrangement to the left or right of the door)

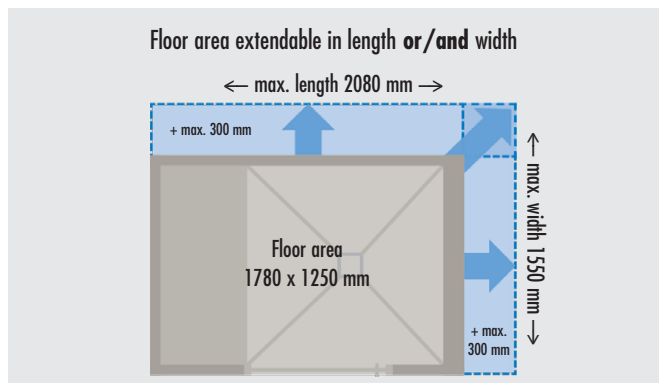

Accessories (optional)

- Shower base set: shower base and substrate element, horizontal drain and hair trap (see page 16)
- Additional accessories from page 38: Panel / Inclined roof element / Light / Sound / Heating / Steam / Technical panel / Maintenance opening / Floor drain supports and accessories / Mounting accessories

CAB-R-GF 1780/1250

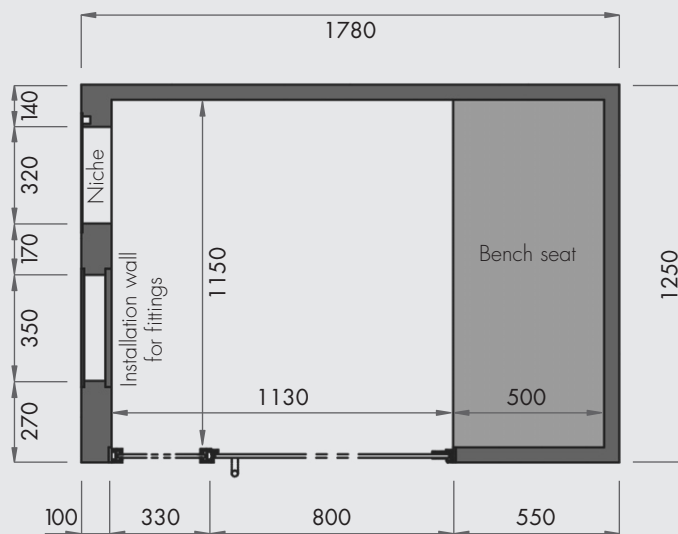

Dimensions in mm

(Illustration shows the version 'R.RL')

## ■ PRODUCT SPECIFICATIONS – LUX ELEMENTS®-SPA CAB-R-GF 1780/1250 ...

Packaging specifications on request

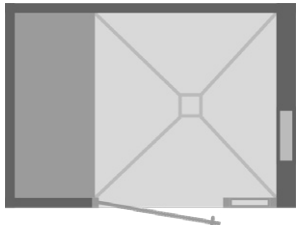
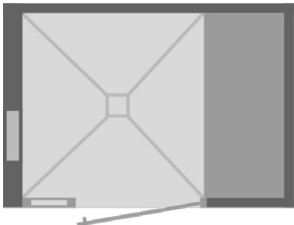
ARTICLE-NUMBER	ARTICLE-NAME / ARTICLE-DESCRIPTION	UNIT	PRICE / UNIT €
	 <p><b>CAB-R-GF 1780/1250 L.L.R.*</b> door DIN <u>left</u> / bench seat <u>left</u> of the door / installation wall <u>right</u> of the door</p>		
	 <p><b>CAB-R-GF 1780/1250 R.R.L.*</b> door DIN <u>right</u> / bench seat <u>right</u> of the door / installation wall <u>left</u> of the door</p>		

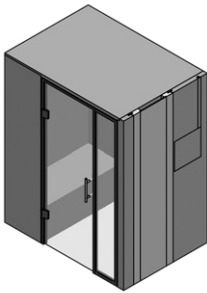
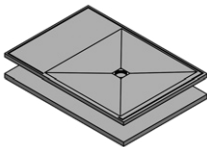
Spa shower				
 <p>(Illustration shows the version 'L.L.R.')</p>	<p><b>CAB-R-GF 1780/1250 ...</b>, rectangular spa shower with glass front as kit, 1780 x 1250 x 2200 mm, wall thickness 50 mm, one wall 100 mm thick as installation wall (arrangement <b>left</b> or <b>right</b> of the door), incl. installation panel and niche 320 x 320 mm, roof shape FLAT, floor-to-ceiling glass profile construction 1130 x 2150 mm, powder-coated dark grey metallic DB 703, door version DIN <b>left</b> or <b>right</b>, with glass door incl. handle, bench seat with cavity for pipe/cable laying (arrangement <b>left</b> or <b>right</b> of the door)  <b>optional: CAB-E...</b>, infinitely variable extension of the spa shower by a maximum of 300 mm in length <b>or/and</b> width, max. length 2080 mm, max. width 1550 mm</p>			
	<b>LESPA1022</b>	<b>CAB-R-GF 1780/1250 L.L.R.</b> , glass profile construction door version DIN <b>left</b> , bench seat <b>left</b> of the door, installation wall <b>right</b> of the door	set	6.028,50
	<b>LESPA1023</b>	<b>CAB-R-GF 1780/1250 R.R.L.</b> , glass profile construction door version DIN <b>right</b> , bench seat <b>right</b> of the door, installation wall <b>left</b> of the door	set	6.028,50
	<b>LESPA1200</b>	<b>CAB-E-1</b> , infinitely variable extension of the spa shower by a maximum of 300 mm in length <b>or</b> width	surcharge	320,00
	<b>LESPA1201</b>	<b>CAB-E-2</b> , infinitely variable extension of the spa shower by a maximum of 300 mm in length <b>and</b> width	surcharge	462,00
Shower base				
 <p>(Illustration shows the version 'L.R.')</p>	<p><b>CAB-BP-R-GF 1780/1250 ...</b>, shower base set consisting of multi-part shower base element 1780 x 1250 x 30/45 mm with built-in and sealed floor drain fitting frame 135 x 135 mm, multi-part substrate element 1780 x 1250 x 55 mm, floor drain support DN 50 horizontal incl. odour trap and hair trap  <b>optional: CAB-BP E...</b>, infinitely variable extension of the shower base set by a maximum of 300 mm in length <b>or/and</b> width, max. length 2080 mm, max. width 1550 mm</p>			
	<b>LESPA1114</b>	<b>CAB-BP-R-GF 1780/1250 LR</b> , for CAB-R-GF 1780/1250 L.L.R.	set	1.016,69
	<b>LESPA1115</b>	<b>CAB-BP-R-GF 1780/1250 RL</b> , for CAB-R-GF 1780/1250 R.R.L.	set	1.016,69
	<b>LESPA1203</b>	<b>CAB-BP E-1</b> , infinitely variable extension of the shower base set by a maximum of 300 mm in length <b>or</b> width	surcharge	179,90
	<b>LESPA1204</b>	<b>CAB-BP E-2</b> , infinitely variable extension of the shower base set by a maximum of 300 mm in length <b>and</b> width	surcharge	318,90

Further accessories from page 38 / Floor drain supports and accessories see page 54 / Mounting accessories see page 56

\* Illustration incl. base

 Cabin configurator and technical documentation to download, see [www.luxelements-privatespa.com](http://www.luxelements-privatespa.com)

Rectangular basic shape, with two benches  
**CAB-R 2000/950**

- Spa shower for two persons
- Floor area 2000 x 950 mm, wall thickness 50 mm, roof shape FLAT (total height 2200 mm)
- Stepless extension by a maximum of 300 mm possible on one or both sides
- With installation wall (100 mm thick) opposite the door, incl. Installation panel and Nischen
- Glass profile construction (2150 mm high): block frame, glass door incl. handle (door version DIN left or right)
- Two bench seats with cavity for pipe/cable laying (arrangement to the left or right of the door)



Accessories (optional)

- Shower base set: shower base and substrate element, horizontal drain and hair trap (see page 16)
- Additional accessories from page 38: Panel / Inclined roof element / Light / Sound / Heating / Steam / Technical panel / Maintenance opening / Floor drain supports and accessories / Mounting accessories

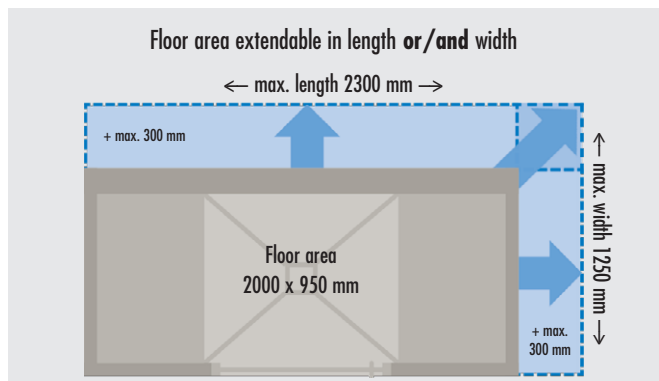

CAB-R 2000/950

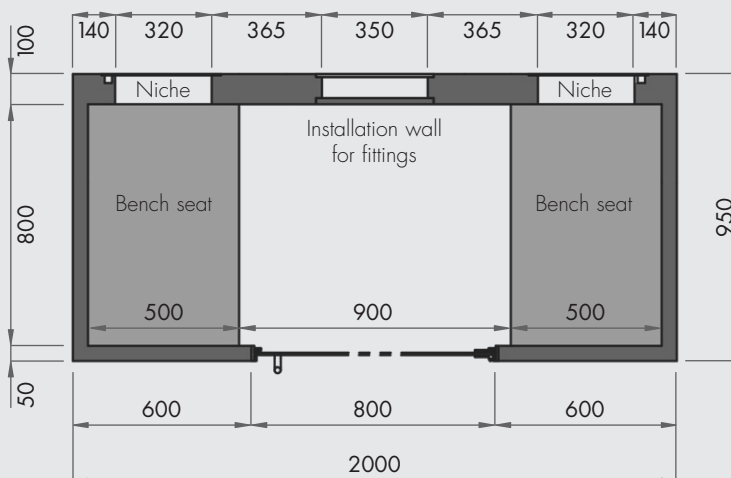

Dimensions in mm

(Illustration shows the version 'R')

## ■ PRODUCT SPECIFICATIONS – LUX ELEMENTS®-SPA CAB-R 2000/950 ...

Packaging specifications on request

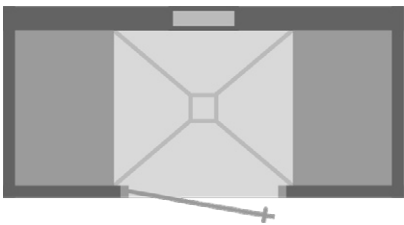
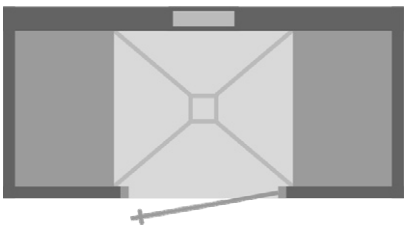
ARTICLE-NUMBER	ARTICLE-NAME / ARTICLE-DESCRIPTION	UNIT	PRICE / UNIT €
			
<b>CAB-R 2000/950 L</b> door DIN <u>left</u> / bench seat left and right of the door / installation wall opposite the door			
			
<b>CAB-R 2000/950 R</b> door DIN <u>right</u> / bench seat left and right of the door / installation wall opposite the door			

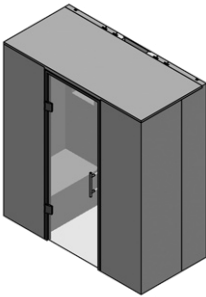
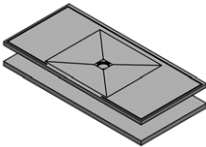
Spa shower				
 <p><i>(Illustration shows the version 'L')</i></p>	<b>CAB-R 2000/950 ...</b> , rectangular spa shower as kit, 2000 x 950 x 2200 mm, wall thickness 50 mm, one wall 100 mm thick as installation wall (arrangement opposite the door), incl. installation panel and niche 320 x 320 mm, roof shape FLAT, floor-to-ceiling glass profile construction 800 x 2150 mm, powder-coated dark grey metallic DB 703, door version DIN <b>left</b> or <b>right</b> , with glass door incl. handle, bench seat with cavity for pipe/cable laying (arrangement left and right of the door) <b>optional: CAB-E...</b> , infinitely variable extension of the spa shower by a maximum of 300 mm in length <b>or/and</b> width, max. length 2300 mm, max. width 1250 mm			
	<b>LESPA1024</b>	<b>CAB-R 2000/950 L</b> , glass profile construction door version DIN <b>left</b>	set	5.298,38
	<b>LESPA1025</b>	<b>CAB-R 2000/950 R</b> , glass profile construction door version DIN <b>right</b>	set	5.298,38
	<b>LESPA1200</b>	<b>CAB-E-1</b> , infinitely variable extension of the spa shower by a maximum of 300 mm in length <b>or</b> width	surcharge	320,00
	<b>LESPA1201</b>	<b>CAB-E-2</b> , infinitely variable extension of the spa shower by a maximum of 300 mm in length <b>and</b> width	surcharge	462,00
Shower base				
	<b>CAB-BP-R 2000/950</b> , shower base set consisting of multi-part shower base element 2000 x 950 x 30/45 mm with built-in and sealed floor drain fitting frame 135 x 135 mm, multi-part substrate element 2000 x 950 x 55 mm, floor drain support DN 50 horizontal incl. odour trap and hair trap <b>optional: CAB-BP E...</b> , infinitely variable extension of the shower base set by a maximum of 300 mm in length <b>or/and</b> width, max. length 2300 mm, max. width 1250 mm			
	<b>LESPA1116</b>	<b>CAB-BP-R 2000/950</b> , for CAB-R 2000/950 L or R	set	883,51
	<b>LESPA1203</b>	<b>CAB-BP E-1</b> , infinitely variable extension of the shower base set by a maximum of 300 mm in length <b>or</b> width	surcharge	179,90
	<b>LESPA1204</b>	<b>CAB-BP E-2</b> , infinitely variable extension of the shower base set by a maximum of 300 mm in length <b>and</b> width	surcharge	318,90

Further accessories from page 38 / Floor drain supports and accessories see page 54 / Mounting accessories see page 56

\* Illustration incl. base

 Cabin configurator and technical documentation to download, see [www.luxelements-privatespa.com](http://www.luxelements-privatespa.com)

### Panel **CAB-DA B**

- Hard foam support element for the creation of an on-site panel from the cabin roof to the ceiling
- Dimensions: 2500 x 600 x 30 mm
- Including 1 cartridge mounting adhesive
- Easy to cut to the desired size

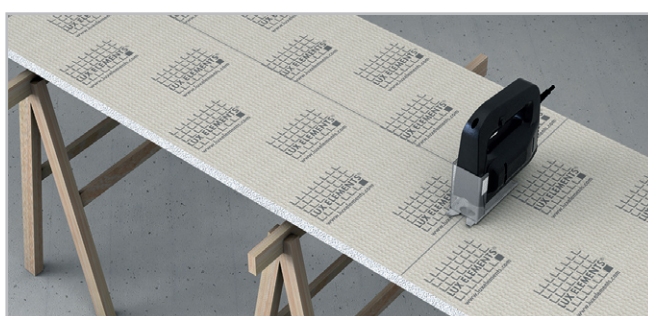
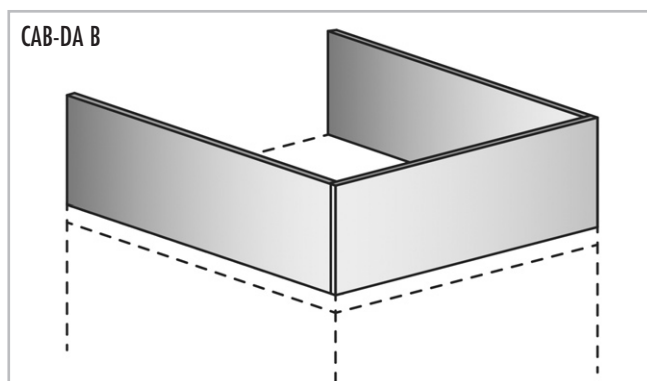

■ **PRODUCT SPECIFICATIONS – LUX ELEMENTS®-SPA CAB-DA B**

Packaging specifications on request

ARTICLE-NUMBER	ARTICLE-NAME / ARTICLE-DESCRIPTION	UNIT	PRICE / UNIT €
----------------	------------------------------------	------	----------------

**Panelling depending on the installation situation**

Position panel =



Installation in a niche

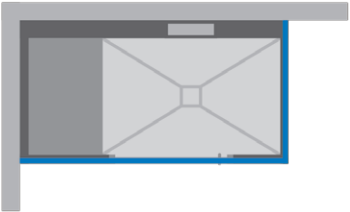

Installation in a corner

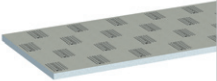

Installation in front of a wall

	<b>LESPA1205</b> CAB-DA B, hard foam support element, 2500 x 600 x 30 mm, for the creation of an on-site panel from the cabin roof to the ceiling, incl. 1 cartridge mounting adhesive	piece	85,15
--	--	-------	-------

Cabin configurator and technical documentation to download, see [www.luxelements-privatespa.com](http://www.luxelements-privatespa.com)

### Inclined roof element

#### **CAB-DA MONO**

- Inclined roof element, 100 mm thick
- Increase in height of overall construction by 50 mm to 2250 mm (without floor)
- For use as a steam shower
- For diverting condensation droplets to the side wall
- Optional: hard foam support element as a panel from the roof to the ceiling **CAB-DA B** (see page 38)
- Optional: LED built-in spotlights **CAB-LI P-WW-2** (see page 42)





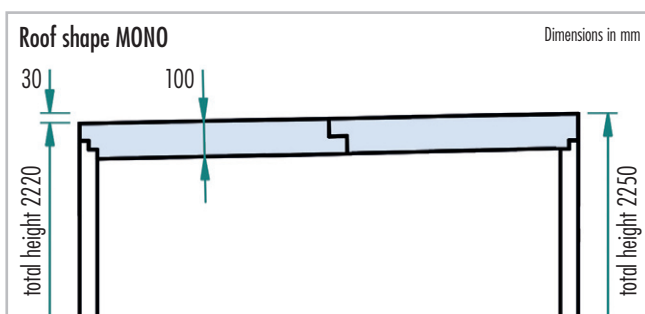
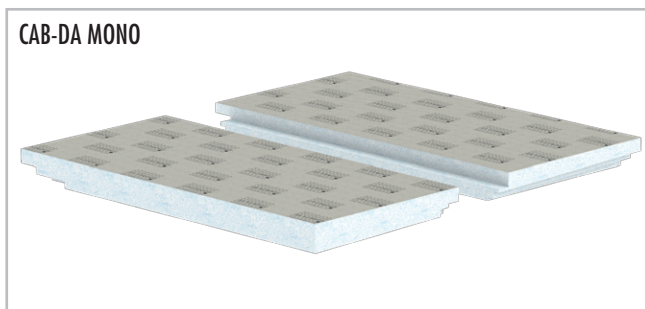

**CAB-DA MONO**





■ **PRODUCT SPECIFICATIONS – LUX ELEMENTS®-SPA CAB-DA MONO**

Packaging specifications on request

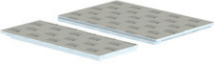
ARTICLE-NUMBER	ARTICLE-NAME / ARTICLE-DESCRIPTION	UNIT	PRICE / UNIT €
<b>Slope direction roof element CAB-DA MONO</b>			
<div style="display: flex; justify-content: space-around; align-items: flex-end;"> <div style="text-align: center;">  <p><b>CAB-F ...</b> Pentagonal basic shape</p> </div> <div style="text-align: center;">  <p><b>CAB-Q ...</b> Square basic shape</p> </div> <div style="text-align: center;">  <p><b>CAB-R ...</b> Rectangular basic shape with one bench</p> </div> <div style="text-align: center;">  <p><b>CAB-R ...</b> Rectangular basic shape with two benches</p> </div> </div>			
	<b>LESPA1202 CAB-DA MONO</b> , inclined roof element, 100 mm thick, increase in height of overall construction by 50 mm	surcharge	352,00

 Cabin configurator and technical documentation to download, see [www.luxelements-privatespa.com](http://www.luxelements-privatespa.com)

### Light **CAB-LI**

#### Light rope – CAB-LI L-WW NI

- Flexible light rope
- Warm white, 24 V, protection class IP 67
- Suitably pre-assembled for one or two niches
- Including power supply unit



CAB-LI L-WW NI



#### LED built-in spotlights – CAB-LI P-WW 2

- 2x LED built-in spotlights warm white, dimmable
- Round, colour chrome-matt
- Protection class IP 65
- Including two mounting plates factory-integrated into the flat roof
- Including power supply units







CAB-LI P-WW 2

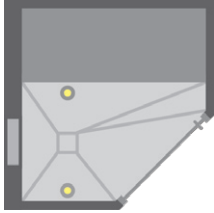
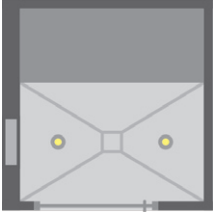
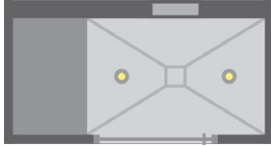
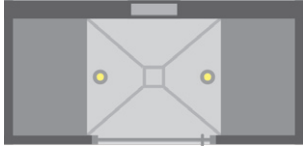

■ PRODUCT SPECIFICATIONS – LUX ELEMENTS®-SPA CAB-LI

Packaging specifications on request

ARTICLE-NUMBER	ARTICLE-NAME / ARTICLE-DESCRIPTION	UNIT	PRICE / UNIT €
<b>Position LED built-in spotlights CAB-LI P-WW 2</b>			
Position LED built-in spotlights = 			
			
<b>CAB-F ...</b> Pentagonal basic shape	<b>CAB-Q ...</b> Square basic shape	<b>CAB-R ...</b> Rectangular basic shape with one bench	<b>CAB-R ...</b> Rectangular basic shape with two benches
	<b>LESPA1206</b> <b>CAB-LI L-WW NI-1</b> , 1x light rope warm white, flexible, 18 mm x 10 mm, protection class IP 67, 24 V, 5 m supply cable, suitably pre-assembled for one niche, incl. power supply unit	set	141,61
 2x	<b>LESPA1207</b> <b>CAB-LI L-WW NI-2</b> , 2x light rope warm white, flexible, 18 mm x 10 mm, protection class IP 67, 24 V, 5 m supply cable, suitably pre-assembled for two niches, incl. power supply unit	set	236,81
 2x	<b>LESPA1208</b> <b>CAB-LI P-WW 2</b> , 2x LED built-in spotlights warm white, dimmable, round, colour chrome-matt, diameter 86 mm, protection class IP 65 (on front side), incl. 2 mounting plates factory-integrated into the flat roof, incl. 2 power supply units	set	415,31



Cabin configurator and technical documentation to download, see [www.luxelements-privatespa.com](http://www.luxelements-privatespa.com)

### Sound

#### **CAB-SO KSW**

- Structure-borne sound converter for mid and high frequency sound reproduction on oscillating surface
- 'Invisible loudspeaker' – no negative influence on the wall design
- Including a hanger bolt and a mounting plate integrated into the roof for secure fastening
- Can be connected to conventional amplifiers
- Dust-tight and waterproof according to IP 68

#### ■ Technical Specification

Rated power:	20 W
Maximum musical power:	30 W
Resonance frequency:	200 Hz

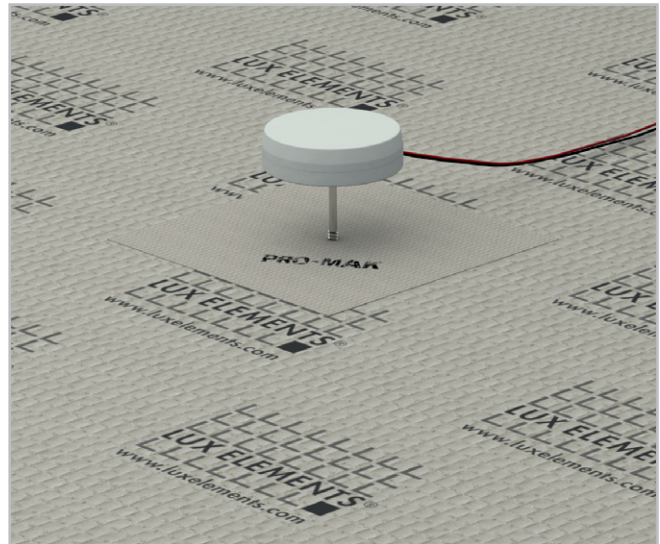

■ **PRODUCT SPECIFICATIONS – LUX ELEMENTS®-SPA CAB-SO KSW**

Packaging specifications on request

ARTICLE-NUMBER	ARTICLE-NAME / ARTICLE-DESCRIPTION	UNIT	PRICE / UNIT €
<b>Position structure-borne sound converter CAB-SO KSW</b>			
Position structure-borne sound converter = ●			
	<b>LESPA1209</b> CAB-SO KSW, structure-borne sound converter, for mid and high frequency sound, diameter 76,5 mm, cable length 3 m, IP 68, including a hanger bolt and a mounting plate integrated into the roof for secure fastening	piece	132,62

Cabin configurator and technical documentation to download, see [www.luxelements-privatespa.com](http://www.luxelements-privatespa.com)

Heating

**CAB-HE E-BA**

- For all bench seats: factory-installed heating mat with temperature sensor
- Two versions: for one or two benches
- Including electronic temperature controller with time control (not suitable for damp rooms, protection class IP 30)

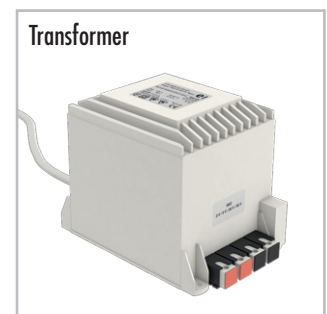
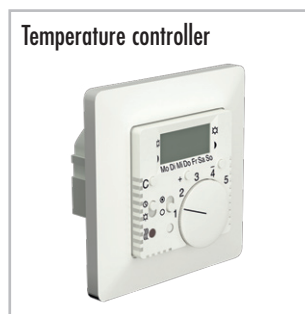
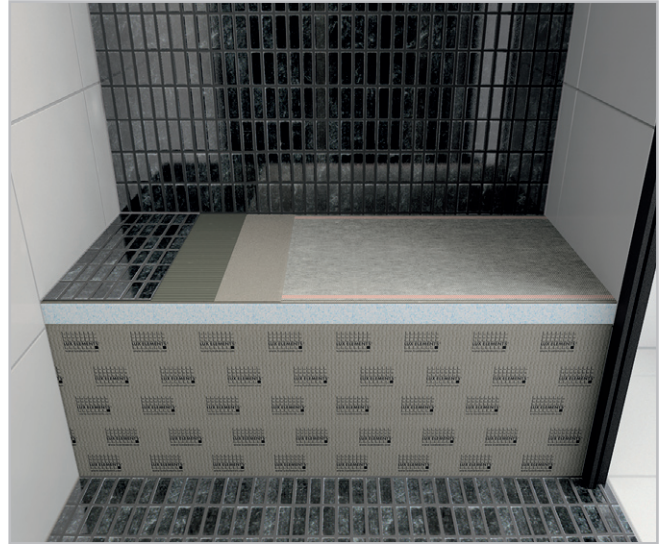

CAB-HE E-BA – construction scheme seat heating

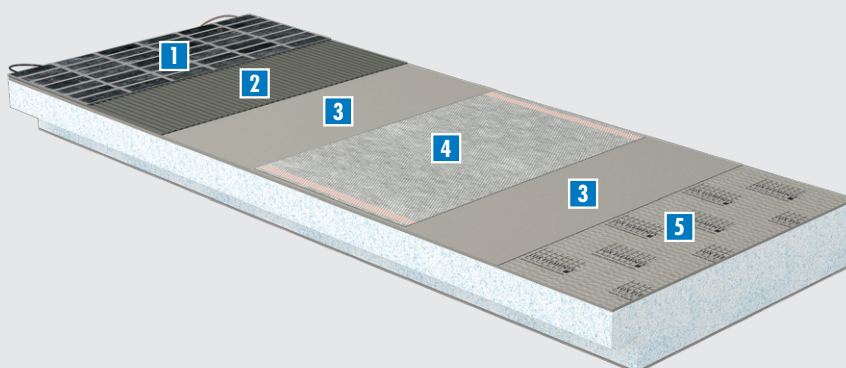

- 1** Tiles
- 2** Tile adhesive
- 3** Mortar layer
- 4** Seat heating CAB-HE E-BA
- 5** Hard foam support element (bench)

The seat heating is installed at the factory.

## ■ PRODUCT SPECIFICATIONS – LUX ELEMENTS®-SPA CAB-HE E-BA

Packaging specifications on request

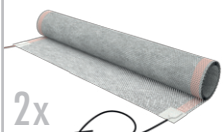
	ARTICLE-NUMBER	ARTICLE-NAME / ARTICLE-DESCRIPTION	UNIT	PRICE / UNIT €
	<b>LESPA1210</b>	<b>CAB-HE E-BA-1</b> , 1x seat heating, factory-installed heating mat (162 W/m <sup>2</sup> , 36 V) with temperature sensor, for all CAB models with a bench seat, incl. electronic temperature controller with time control (12 A, 230 V AC) for electric heating set, incl. transformer	surcharge	874,92
	<b>LESPA1211</b>	<b>CAB-HE E-BA-2</b> , 2x seat heating, factory-installed heating mat (162 W/m <sup>2</sup> , 36 V) with temperature sensor, for CAB-R 2000/950 (two benches) incl. electronic temperature controller with time control (12 A, 230 V AC) for electric heating set, incl. transformer	surcharge	1.147,97



Cabin configurator and technical documentation to download, see [www.luxelements-privatespa.com](http://www.luxelements-privatespa.com)

### Steam

#### CAB-TE DE

- Steam inlet plate 390 x 390 x 30 mm
- Temperature-resistant supporting
- Safe feed-through of a steam pipe
- For the on-site creation of a steam inlet
- Size adapted to installation panel (see page 13)
- Including sealing sleeve 500 x 500 mm

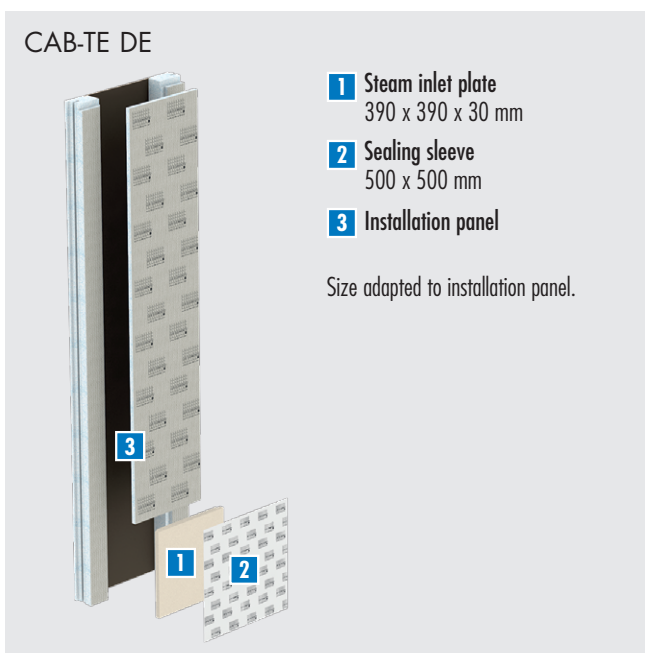
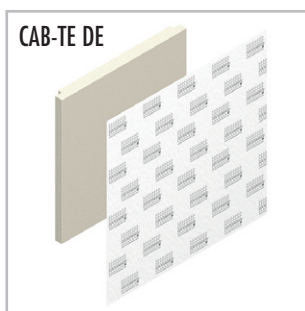



## ■ PRODUCT SPECIFICATIONS – LUX ELEMENTS®-SPA CAB-TE DE

Packaging specifications on request

	ARTICLE-NUMBER	ARTICLE-NAME / ARTICLE-DESCRIPTION	UNIT	PRICE / UNIT €
	<b>LESPA1212</b>	<b>CAB-TE DE</b> , steam inlet plate 390 x 390 x 30 mm, size adapted to installation panel, incl. sealing sleeve 500 x 500 mm, for the on-site creation of a steam inlet	set	80,29



Cabin configurator and technical documentation to download, see [www.luxelements-privatespa.com](http://www.luxelements-privatespa.com)

## Technical panel CAB-TE TPA

Consisting of these components:

- Cladding elements:
  - Fastening element (1700 x 500 x 30 mm) with a factory-integrated mounting plate for the installation of technical components
  - Side element (1750 x 400 x 30 mm), depth can be shortened
- Maintenance opening (400 x 600 mm, distance of lower edge from the floor 725 mm), including
  - Metal frame, rotatable by 180°: opening to the right or left possible
  - Easy opening and closing by light pressure
  - Front panel for thinner covering thicknesses
  - Factory milling for maintenance opening in the wall element
  - Fillers for adaptation to covering thicknesses of 2 or 12 mm

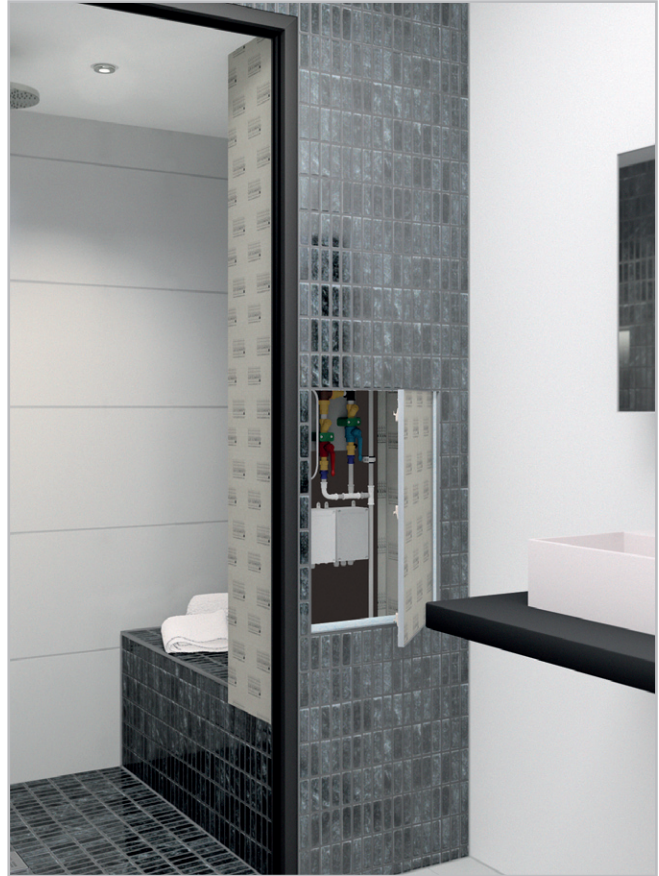

CAB-TE TPA

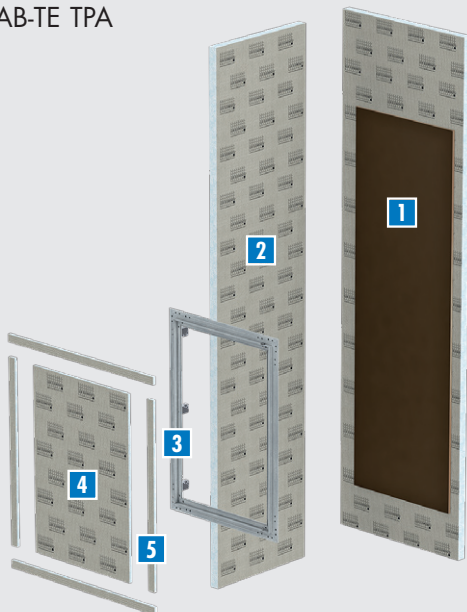

- 1** Fastening element  
1700 x 500 x 30 mm  
with a factory-integrated mounting plate  
1200 x 400 x 9 mm
- 2** Side element  
1750 x 400 x 30 mm  
depth can be shortened
- 3** Metal frame maintenance opening  
easy opening and closing
- 4** Front panel  
usable depending on the thickness of the covering
- 5** Fillers  
usable depending on the thickness of the covering

Dimensions maintenance opening =  
400 x 600 mm

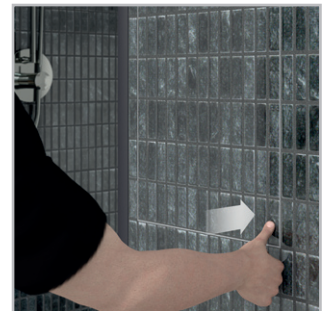

Maintenance opening technical panel CAB-TE TPA – Adaptation of the installation height by fillers for covering thicknesses of 2 or 12 mm:



Application with plaster:  
with front panel / fillers on frame







Application with mosaic tiles:  
with front panel / fillers on frame



Application with natural stone:  
without front panel / fillers under frame

■ PRODUCT SPECIFICATIONS – LUX ELEMENTS®-SPA CAB-TE TPA

Packaging specifications on request

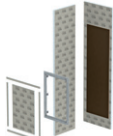
ARTICLE-NUMBER	ARTICLE-NAME / ARTICLE-DESCRIPTION	UNIT	PRICE / UNIT €		
<p><b>Position technical panel (incl. maintenance opening) CAB-TE TPA (depth can be shortened)</b></p> <p>Position technical panel = </p>					
 <p><b>CAB-F ...</b> Pentagonal basic shape</p>	 <p><b>CAB-Q ...</b> Square basic shape</p>	 <p><b>CAB-R ...</b> Rectangular basic shape with one bench</p>	 <p><i>optionally left or right</i> <b>CAB-R ...</b> Rectangular basic shape with two benches</p>		
	<p><b>LESPA1213 CAB-TE TPA</b>, technical panel, consisting of fastening element (1700 x 500 x 30 mm) with factory-integrated mounting panel (1200 x 400 x 9 mm) for the installation of technical components, side element (1750 x 400 x 30 mm, can be shortened), maintenance opening (400 x 600 mm), supplied loose, suitable milling in the wall element, incl. front panel and fillers (adaptation to covering thicknesses of 2 or 12 mm)</p>	surcharge	448,51		

 Cabin configurator and technical documentation to download, see [www.luxelements-privatespa.com](http://www.luxelements-privatespa.com)

## Maintenance opening CAB-TE REV 300

- Dimensions: 300 x 300 mm
- Access from the outside of the cabin to the bench seat cavity (see page 11)
- Easy maintenance of pipes/cables and technical components
- Metal frame, rotatable by 180°: opening to the right or left possible
- Easy opening and closing by light pressure
- Front panel for thinner covering thicknesses
- Factory milling for maintenance opening in the wall element
- Fillers for adaptation to covering thicknesses of 2 or 12 mm

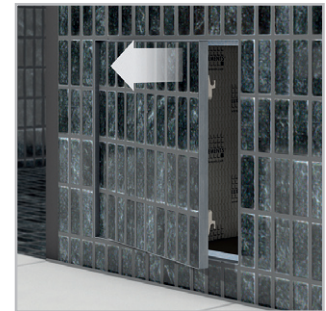
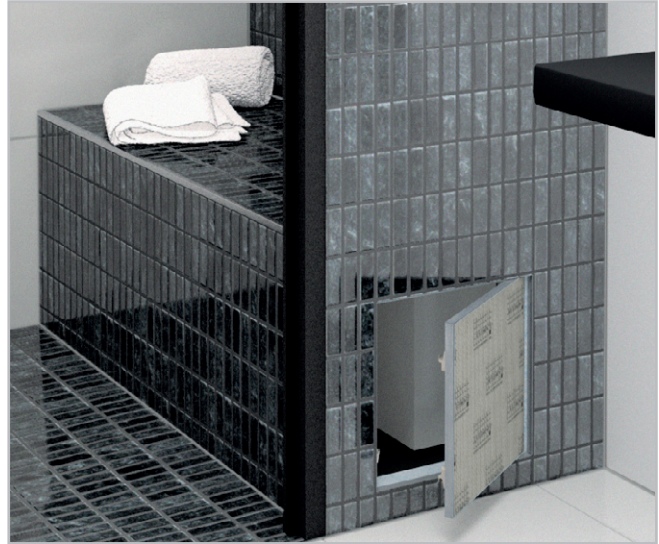

CAB-TE REV 300

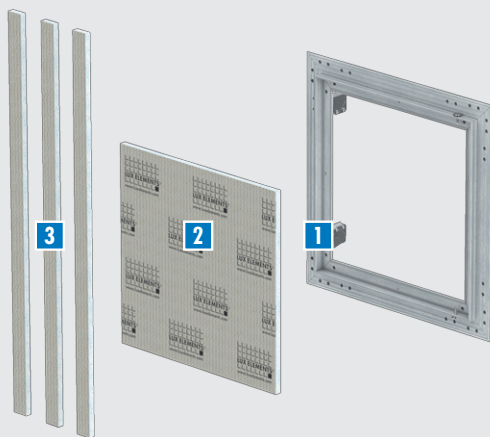

- 1** Metal frame maintenance opening – opening to the right or left possible
- 2** Front panel – usable depending on the thickness of the covering
- 3** Fillers – usable depending on the thickness of the covering

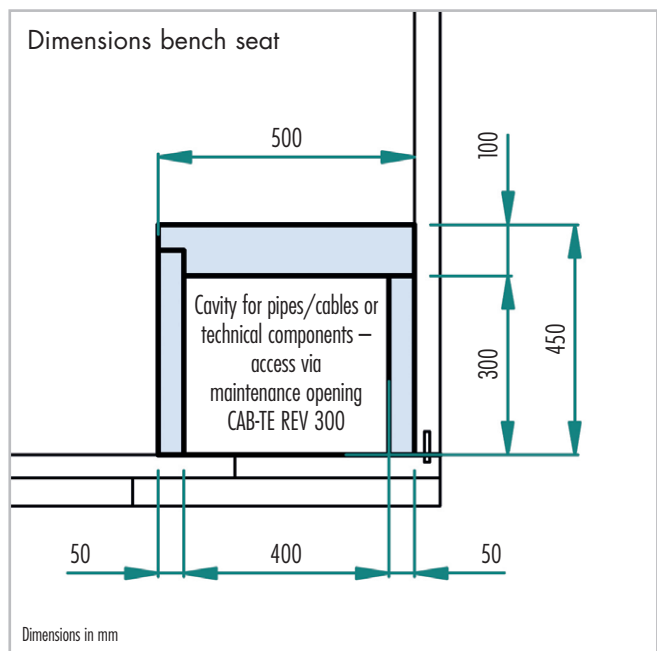

Maintenance opening CAB-TE REV 300 – Adaptation of the installation height by fillers for covering thicknesses of 2 or 12 mm:



Application with plaster:  
with front panel / fillers on frame

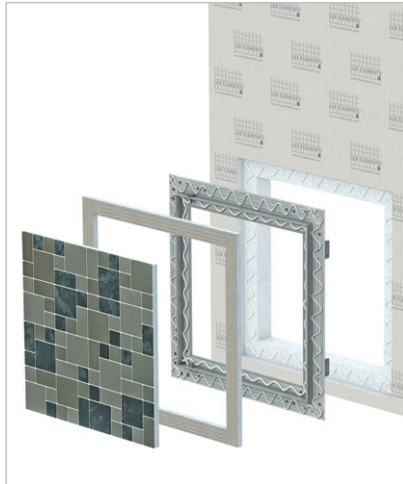



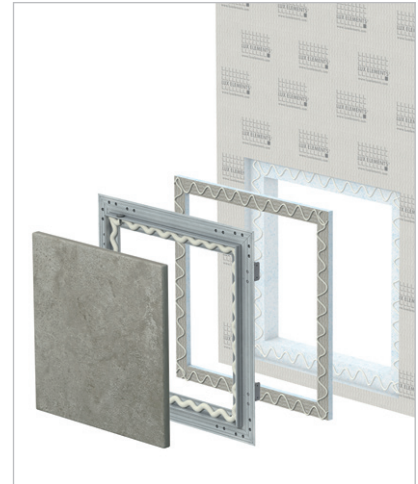

Application with mosaic tiles:  
with front panel / fillers on frame



Application with natural stone:  
without front panel / fillers under frame

■ PRODUCT SPECIFICATIONS – LUX ELEMENTS®-SPA CAB-TE REV 300

Packaging specifications on request

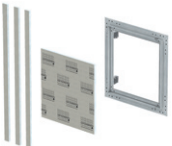
ARTICLE-NUMBER	ARTICLE-NAME / ARTICLE-DESCRIPTION	UNIT	PRICE / UNIT €
<b>Position maintenance opening CAB-TE REV 300</b>			
Position maintenance opening =			
	<b>CAB-F ...</b> Pentagonal basic shape		
	<b>CAB-Q ...</b> Square basic shape		
	<b>CAB-R ...</b> Rectangular basic shape with one bench		
	<b>CAB-R ...</b> Rectangular basic shape with two benches <i>optionally left or right</i>		
	<b>LESPA1214</b> CAB-TE REV 300, maintenance opening 300 x 300 mm, supplied loose, incl. suitable milling in the wall element and fillers for covering thicknesses of 2 or 12 mm	surcharge	168,95

 Cabin configurator and technical documentation to download, see [www.luxelements-privatespa.com](http://www.luxelements-privatespa.com)

## Floor drain supports and accessories **TUB**

### Grate fitting frame:

- Grate fitting frame for floor drain support DN 50 horizontal (TUB-BA-W):
  - with standard grate: TUB-RA-S
  - with design grate: TUB-RA-D...
  - with tileable cover: TUB-RA-DV
- Can be shortened, universal height adjustment to the covering thickness

### Drainage capacity in accordance with DIN EN 1253 [l/s]:

TUB-BA-W, standard odour trap DN 50 horizontal

- with standard grate TUB-RA-S: 1,0 l/s
- with design grate TUB-RA-DA: 1,1 l/s
- with design grate TUB-RA-DC: 1,2 l/s
- with design grate TUB-RA-DM: 1,2 l/s
- with design grate TUB-RA-DL: 1,1 l/s
- with design grate TUB-RA-DV: 1,3 l/s

### Thickness of surface covering (tile and adhesive):

- TUB-RA-S/DA/DC/DM/DL: for the shower tray: minimum 5 mm
- TUB-RA-DV: for the shower tray: minimum 5 mm / for tileable cover: 8 mm

**Please note:** The installation of a hair trap (TUB-BAZ HS) can reduce the drainage capacity by up to 0.3 l/s. Further information see data sheet TUB.

### Accessories:

- Reducer, DN 50 to DN 40, with lip seal: TUB-BAZ DN 50/40
- Adapter, DN 50 to British Standard: TUB-BAZ BST

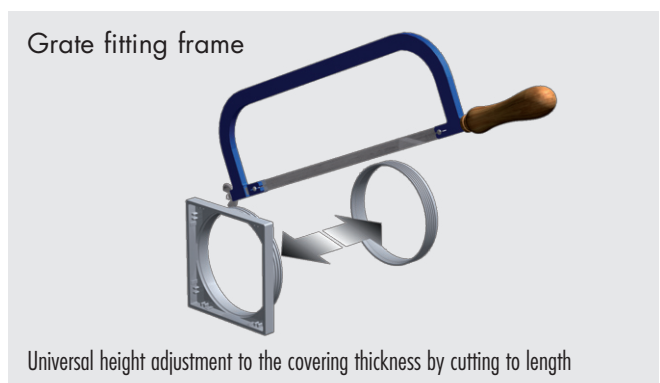
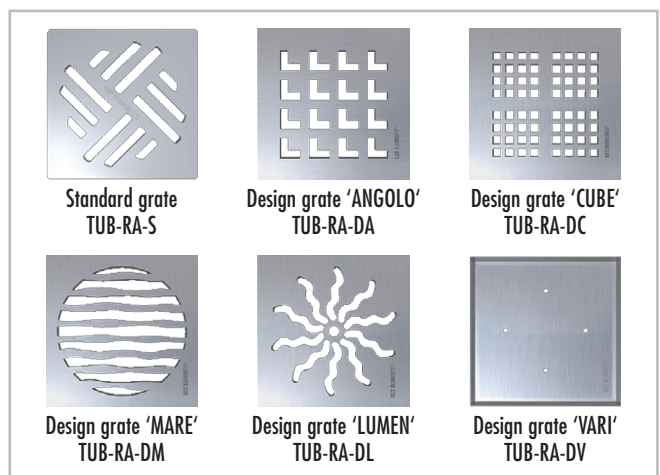
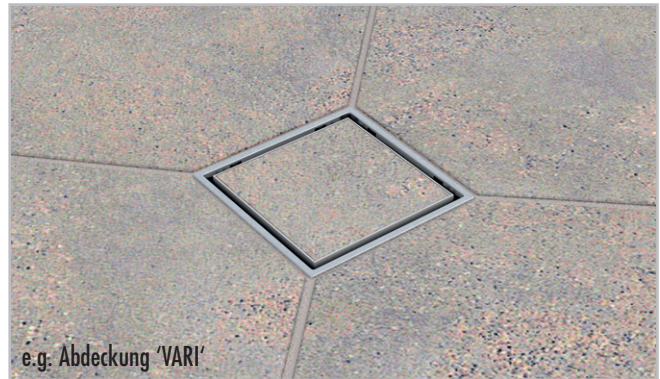

## ■ PRODUCT SPECIFICATIONS – TUB FLOOR DRAIN SUPPORTS AND ACCESSORIES

Packaging specifications on request

	ARTICLE-NUMBER	ARTICLE-NAME / ARTICLE-DESCRIPTION	ABMESSUNGEN LENGTH x WIDTH	UNIT	PRICE / UNIT €
	<b>LTUBE1100</b>	<b>TUB-RA-S</b> , grate fitting frame made of ABS and standard stainless steel grate, universal height adjustment to suit covering thickness is possible	external frame dimensions: 130 x 130 mm, grate: 120 x 120 mm	set	32,19
	<b>LTUBE1104</b>	<b>TUB-RA-DA</b> , grate fitting frame made from ABS, with frame and design grate 'ANGOLO' made of stainless steel, universal height adjustment to suit covering thickness is possible	external frame dimensions: 132 x 132 mm, grate: 120 x 120 mm	set	101,57
	<b>LTUBE1105</b>	<b>TUB-RA-DC</b> , grate fitting frame made from ABS, with frame and design grate 'CUBE' made of stainless steel, universal height adjustment to suit covering thickness is possible	external frame dimensions: 132 x 132 mm, grate: 120 x 120 mm	set	111,96
	<b>LTUBE1106</b>	<b>TUB-RA-DM</b> , grate fitting frame made from ABS, with frame and design grate 'MARE' made of stainless steel, universal height adjustment to suit covering thickness is possible	external frame dimensions: 132 x 132 mm, grate: 120 x 120 mm	set	101,33
	<b>LTUBE1107</b>	<b>TUB-RA-DL</b> , grate fitting frame made from ABS, with frame and design grate 'LUMEN' made of stainless steel, universal height adjustment to suit covering thickness is possible	external frame dimensions: 132 x 132 mm, grate: 120 x 120 mm	set	101,37
	<b>LTUBE1108</b>	<b>TUB-RA-DV</b> , grate fitting frame made from ABS, with frame made of stainless steel and tileable cover 'VARI' made of stainless steel, universal height adjustment to suit covering thickness is possible	external frame dimensions: 132 x 132 mm, cover: 110 x 110 mm	set	101,26
	<b>LTUBE1200</b>	<b>TUB-BAZ DN 50/40</b> , reducer, DN 50 to DN 40, with lip seal		piece	11,61
	<b>LTUBE1190</b>	<b>TUB-BAZ BST</b> , adapter, DN 50 to British Standard		piece	11,49



Cabin configurator and technical documentation to download, see  
[www.luxelements-privatespa.com](http://www.luxelements-privatespa.com)

Mounting accessories

**CAB-KIT**

- Required mounting material for processing in a kit:
  - Mounting kit for wall, bench seat and roof elements (without base): **CAB-KIT 1**
  - Mounting kit for sealing the corners and joints for use as a shower: **CAB-KIT 2**
  - Mounting kit for the extended sealing of the surfaces for use as a steam shower: **CAB-KIT 3**

**COL-AK**

- Fixing adhesive for shower base and substrate element
- Stable, fast bonding, waterproof, low on chromate in accordance with EC directive 2003/53/EG

Consumption of COL-AK:



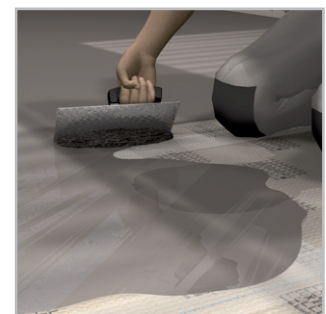
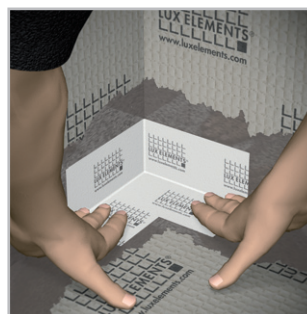
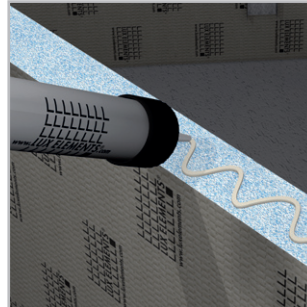

- Laying of substrate element on dots: approx. 6 – 10 kg/m<sup>2</sup> per cm installation height
- Bonding of base element to substrate element: Bonding with 10 mm toothing, 3,0 kg/m<sup>2</sup>, layer thickness 5 mm





**■ PRODUCT SPECIFICATIONS – LUX ELEMENTS®-SPA CAB-KIT / -COL-AK**

Packaging specifications on request

	ARTICLE-NUMBER	ARTICLE-NAME / ARTICLE-DESCRIPTION	UNIT	PRICE / UNIT €
	<b>LESPA1215</b>	<b>CAB-KIT 1</b> , mounting kit for wall, bench seat and roof elements (without base): 5 kg fixing adhesive, 20 m reinforcement, 10 cartridges mounting adhesive, 5 timber wedges, 10 mounting brackets	Kit	268,59
	<b>LESPA1216</b>	<b>CAB-KIT 2</b> , mounting kit for sealing the corners and joints for use as a shower: 50 m sealing tape, 8 pieces sealing tape for inner corners, 4 pieces sealing tape for outer corners, 2x 3,5 kg sealing filler	Kit	250,39
	<b>LESPA1217</b>	<b>CAB-KIT 3</b> , mounting kit for the extended sealing of the surfaces for use as a steam shower: 3x 15 kg sealing filler	Kit	387,40
	<b>LCOLZ1014</b>	<b>COL-AK</b> , fixing adhesive, bag 5 kg	kg	3,31
	<b>LCOLZ1001</b>	<b>COL-AK</b> , fixing adhesive, bag 25 kg	kg	2,86



Cabin configurator and technical documentation to download, see  
[www.luxelements-privatespa.com](http://www.luxelements-privatespa.com)

## Data protection information for business partners

Revised August 2018

### Our handling of your data and your rights

Information according to articles 13, 14 and 21 of the General Data Protection Regulation (GDPR)

In accordance with the EU General Data Protection Regulation (GDPR) valid from 25 May 2018, we wish to take the opportunity with this data protection information to inform you, our business partners, about how we process your personal data and about your rights. This information will be updated whenever necessary and published on [www.luxelements.com](http://www.luxelements.com), where you will also find our data protection information for visitors to our website.

### 1. Who is responsible for the data processing and who is the Data Protection Officer?

Responsible is: LUX ELEMENTS GmbH & Co. KG  
An der Schusterinsel 7  
D - 51379 Leverkusen  
Tel.: +49 (0) 21 71 / 72 12-0  
Fax: +49 (0) 21 71 / 72 12-40  
E-Mail: [info@luxelements.de](mailto:info@luxelements.de)

Our Data Protection Officer Julia Lux can be contacted at the above address or by e-mail to [datenschutz@luxelements.de](mailto:datenschutz@luxelements.de). The contact data are also available online at:

<https://www.luxelements.com/lux/impressum.htm#datenschutz>

### 2. What sources and data are used?

LUX ELEMENTS GmbH & Co. KG processes data that it obtains from the business relationship with you, for example in the context of the handling of customer contracts, personnel and supplier administration, and attendance to commercial agents and prospective customers.

Specifically, the following data in particular are processed:

- identifying data (e.g. name, address and contact data of the business partner, bank account details)
- information on the risk profile of the business partner, including creditworthiness and financial solvency as well as information in accordance with the suitability declaration
- data connected with the execution of the specific order
- tax-relevant data
- contract data for other correspondence (e.g. correspondence with you)
- advertising and sales data (e.g. products and services that are potentially of interest to you)

### 3. What is the purpose of the processing of my data and what is the legal basis for this?

LUX ELEMENTS GmbH & Co. KG processes your data on the following legal basis and for the purposes listed below:

#### 3.1 For the fulfilment of contractual obligations (Article 6, section 1 b) GDPR)

Your data are processed in order to execute our contracts with you, i.e. for example for the carrying out of the service ordered. The purposes of the data processing depend in detail on the specific service and the contract documents.

#### 3.2 In the context of the weighing of interests (Article 6, section 1 f) GDPR)

In addition, your data may be used on the basis of a weighing of interests to protect our justified interests or those of third parties. This takes place for the following purposes:

- general business management and the further development of services, systems and products
- fulfilment of internal requirements and the requirements of our affiliated companies, insurance, checking or administration purposes

- guaranteeing IT security and IT operation
- advertising, market and opinion research
- assertion of legal claims and defence in legal disputes
- prevention and solving of crimes as well as risk management and prevention of fraud

The interest of LUX ELEMENTS GmbH & Co. KG in the respective processing arises from the respective purposes and is otherwise of a business nature (efficient fulfilment of tasks, sales, avoidance of legal risks).

If the specific purpose allows, LUX ELEMENTS GmbH & Co. KG processes your data in pseudonymised or anonymised form.

#### 3.3. On the basis of your consent (Article 6, section 1 a) GDPR)

If you have given your consent to the processing of personal data, the respective consent is the legal basis for the processing mentioned there.

In addition, you may have consented to being contacted by e-mail or telephone for advertising purposes.

You can revoke your consent at any time with effect for the future.

This also applies to declarations of consent that you have made to LUX ELEMENTS GmbH & Co. KG before the coming into force of the GDPR, i.e. before 25 May 2018. The revocation applies only to future processing.

#### 3.4. On account of legal regulations (Article 6, section 1 c) GDPR)

LUX ELEMENTS GmbH & Co. KG is subject to various legal obligations, i.e. legal requirements (e.g. technical checking regulations, industrial health and safety regulations, money laundering laws, tax laws).

The purposes of processing include the checking of identity and age, the prevention of fraud and money laundering, accounting, the evaluation and control of risks (including the creation of a risk profile for business partners, as well as the checking of creditworthiness and the fulfilment of checking and reporting obligations under tax laws).

### 4. Who receives my data?

LUX ELEMENTS GmbH & Co. KG passes on your data only in compliance with the GDPR and the BDSG (German Federal Data Protection Act). Within LUX ELEMENTS GmbH & Co. KG, your data is received by those bodies that require it in order to fulfil the contractual and legal obligations or to fulfil their respective tasks (e.g. Sales, Marketing and Accounts).

In addition, the following bodies may receive your data:

- processors (Art. 28 GDPR) employed by us, in particular in the fields of IT services, logistics, disposal and printing services, who process your data for us according to our instructions
- public bodies and institutions where there is a legal or official obligation
- our respective employees, advisers, representatives, proxies, accountants, service providers
- other bodies for whom you have given us your consent to be given your data

### 5. How long will my data be stored?

We delete your personal data as soon as it is no longer required for the aforementioned purposes. After the termination of the business relationship your personal data will be stored if we are legally obligated to do so. This arises from legal verification and archiving obligations, which are governed among others by the German Commercial Code and Fiscal Code. Accordingly, storage periods may be up to ten years. In addition, it may be the case that personal data is stored for the period during which claims may be asserted against us (legal statute of limitations of three or up to thirty years).

### 6. Are data transmitted to a third-party country or an international organisation?

Your data are transmitted to states outside of the European Economic Area – EEA (third countries) only if this is necessary for the execution of your orders or is legally prescribed or if you have given your consent thereto.

### 7. What other data protection rights do I have?

Under the respective legal conditions, you have the right to information (Article 15 GDPR), to correction (Article 16 GDPR), to deletion (Article 17 GDPR), to restriction of the processing (Article 18 GDPR) and to data transferability (Article 20 GDPR).

In addition, you have the right to complain to a data protection supervisory authority (Article 77 GDPR).

You can assert these rights centrally against LUX ELEMENTS GmbH & Co. KG.

The responsible supervisory authority is the State Officer for Data Protection and Freedom of Information for North Rhine-Westphalia:

Landesbeauftragte für Datenschutz und Informationsfreiheit

Nordrhein-Westfalen

Postfach 20 04 44

D - 40102 Düsseldorf

Tel.: +49 (0) 211 / 3 84 24-0

Fax: +49 (0) 211 / 3 84 24-10

E-Mail: [poststelle@ldi.nrw.de](mailto:poststelle@ldi.nrw.de)

### Right of objection

**You have the right to object to the processing of your personal data for the purposes of direct advertising without giving reasons. If we process your data for the protection of justified interests, you can object to this processing for reasons arising from your particular situation. We will then no longer process your personal data unless we can prove that there are compelling reasons worthy of protection for the processing that outweigh your interests, rights and freedoms or that the processing serves the assertion or exercising of, or defence against legal claims.**

### 8. What data protection rights can I assert as the person affected?

Within the framework of our business relationship you need only provide such personal data as are necessary for the establishment, conduction and termination of a business relationship or to whose acquisition we are legally obligated.

## General terms and conditions LUX ELEMENTS GmbH & Co. KG

Released December 2017

### I) General

1. LUX ELEMENTS GmbH & Co. KG (the Seller) accepts and executes all orders exclusively based on the following terms and conditions.
2. The Buyer accepts these terms and conditions by placing his order. Conflicting purchase terms of the Buyer shall only be binding if accepted by the Seller in writing.
3. Ancillary verbal agreements including discounts, bonuses and dispositions shall only be valid if confirmed in writing by the Seller.

### II) Terms of delivery

1. Deliveries are made at the Seller's discretion from the Leverkusen plant or from the Seller's warehouse. Deliveries are at the Buyer's risk if the Buyer is a Merchant and in any case to the account of the Buyer.
2. If the Buyer does not accept the goods at the agreed time, the Seller shall be entitled to withdraw from the delivery contract after setting a one-week acceptance period. The provisions of the German Civil Code (BGB) regarding default of acceptance shall remain unaffected.
3. If, at the request of the Buyer, the Seller takes back any goods as a gesture of goodwill, the Buyer shall bear the return freight. For the processing and handling of the goods, 15 percent of the goods' net value shall be deducted from the credit note to be issued by the Seller. Only goods from the currently valid product range can be returned, with the exception of construction chemical products and custom-made products.

### III) Delayed delivery

1. All sales are subject to the timely supply to us by our subsuppliers. This does not apply if the Seller is responsible for the delay.
2. In case of force majeure, in particular labour disputes, official intervention and operational breakdowns for which the seller is not responsible, the delivery period shall be extended by the duration of the disruption provided that it does not take an unreasonably long time. In case of delays beyond this time, the parties shall mutually agree whether to adhere to or cancel the contract. The buyer shall not be entitled to claim damages in this regard.
3. In the event of delay of the Seller, the Buyer shall grant a period of grace of 10 days unless a firm deal has been agreed upon. This grace period can be set in writing earliest after the expiry of the delivery period.

In the event of delayed delivery, claims for damages due to default shall be excluded in cases of ordinary negligence, if the Buyer is a Merchant, and it is not a firm deal. In any event, in the case of slight negligence, the liability for damages shall be limited to the foreseeable losses.

### IV) Warranty

1. The warranty period shall be one year if the Buyer is a Merchant. The Seller will meet its warranty obligation by means of replacement.
2. The Seller shall not be liable for any consequential loss or damages. This shall not apply for consequential damages arising from injury to life, body or health; or which can be attributed to gross negligence, intent or breach of a substantial contract obligation (cardinal obligation); or in case of damages resulting from a failure to achieve warranted characteristics, quality or durability guarantees. If the Seller is liable for consequential damages and the Buyer is a Merchant, the liability of the Seller shall be limited to the foreseeable losses if the damage arises from the negligent breach of a substantial contract obligation (cardinal obligation).
3. If goods such as joint sealing materials are sold as per sample, the guarantee is limited to the professional compliance with the sample.
4. The information provided in the Seller's datasheets is based on the state of knowledge at the time when the datasheets were issued. They are solely intended to describe the products with view to safety requirements. They do not constitute any assurance of delivery specifications.
5. The instructions for use issued by the Seller should be considered a general guide only. Given the diversity of uses of each product and

taking into account the specific application situation, the Buyer shall be responsible to conduct its own trials.

6. Buyers intending to resell the goods received from the Seller take the sole responsibility for the correct packing, classification and marking of hazardous substances, see art. 15 GefStoffV (German Ordinance on Hazardous Substances). In particular the Buyer shall not be entitled to any claims if the packing, classification or marking provided by the Seller does no longer comply with the current regulations as a result of legal changes made after the delivery of the goods. The Seller explicitly does not assume any obligation to provide information on such legal changes.

7. The same (6) shall apply if goods of the Seller are packed using packing material of the Buyer. In this case the Buyer takes the entire responsibility for the packing and marking. As regards insufficient packing and/or marking, the Buyer shall indemnify the Seller from all third party claims.

### V) Terms of payment

1. The invoice is issued on the day of despatch or availability of the goods after receipt of the delivery note. Unless otherwise agreed, the price shall be calculated based on the prices in effect on the day of delivery.
2. Invoices shall be payable within 14 days of the invoice date after deducting a discount of 2 percent or within 30 days net.
3. The offsetting against counter-claims shall not be permitted unless the Buyer's claims are undisputed or have been determined as legally binding.
4. A significant deterioration of the Buyer's financial situation shall entitle the Seller, with no prejudice to any other rights, to execute the remaining orders on a delivery against payment basis. Under the same preconditions, the Seller's claims for payment from previous deliveries shall become due for immediate payment.
5. Merchants shall be entitled to the right of retention arising from alleged deficiencies of the goods only if the deficiencies of the goods are undisputed or have been determined as legally binding. In all other instances, the Buyer may demonstrate the deficiency of the goods supplied through a professional opinion which is not arbitration opinion and which has been provided by a publicly appointed and sworn expert whereupon the Seller remains free to raise objections to this opinion.

### VI) Retention of title

1. The Seller shall retain title to the delivery items until complete payment of the purchase price. If the Buyer is a Merchant, the Seller shall in addition retain title to the delivery item until all its claims against the Buyer arising out of the entire business relationship have been settled.
2. In the event the goods supplied are processed or combined with other material, the Seller shall become co-owner of the new manufactured items in the ratio the value of goods subject to retention of title bears to the value of the new items so resulting from the production process. The time of such processing decides upon the value of the goods subject to retention of title as well as the value of processing. During the processing, the Buyer shall act on behalf of the Seller without, however, acquiring any entitlement against the Seller as a result of the processing. The Buyer is obliged to store the goods subject to retention of title carefully on behalf of the Seller. If the Seller does not obtain co-ownership of the combination of several items, the Buyer shall already transfer a co-ownership share in accordance with the provisions of section 6 no. 2 sentences 1 and 2. The required declarations of intent are already being executed.
3. Where the new product is resold by the Buyer, the Buyer's claim to the purchase price shall, by way of security, take the place of the product in accordance with the provisions of section 6 no. 2 sentences 1 and 2. The Buyer shall assign the claims to the purchase price on a pro-rata basis to the Seller who hereby accepts the assignment.
4. If the Buyer re-sells the unprocessed goods, the Buyer shall hereby

assign all claims, including any ancillary rights, to the Seller up to the amount of his claims. The Seller hereby accepts the assignment.

5. The amounts collected are to be transferred to a separate account for the benefit of the Seller.
6. If the value of the securities exceeds the Seller's claims by more than 10 percent, the Seller shall, at the request of the Buyer, release the exceeding amount of the securities to the Buyer.
7. The Buyer shall inform the Seller immediately in writing if an attachment is enforced upon the goods subject to retention of title or upon goods in the co-ownership of the Seller or upon claims transferred to the Seller by way of an advance assignment. The Buyer must inform the enforcement authority and the judgment creditor without delay that the goods are subject to retention of title or co-owned by the Seller or the fact that the claim has been assigned to the Seller.

### VII) Place of performance and jurisdiction

1. Place of performance for all goods and services arising from this supply contract is the domicile of the Seller's commercial establishment.
2. For Merchants, the place of jurisdiction for all obligations of the parties (including actions on bills of exchange or cheques) is Leverkusen.

### VIII) Applicable law

The purchase contract shall be subject to German law to the exclusion of the United Nations Convention on Contracts for the International Sale of Goods of 11 April 1980.

### IX) Final provisions

The invalidity of one or more provisions of these terms and conditions shall in no way affect the validity of the remaining provisions.

**LUX ELEMENTS GmbH & Co. KG,**  
**An der Schusterinsel 7, D-51379 Leverkusen,**  
**Tel.: +49 (0)2171-7212-0, Fax: +49 (0)2171-7212-30**



The EUF (European Union of National Tile Associations) has developed the concept '**Healthier Living with Ceramics**' together with its European member associations and sponsor members. This concept is intended as information 'pro tile' for trade, dealers and manufacturers. LUX ELEMENTS is the force behind the project and is actively involved in its implementation.



**D LUX ELEMENTS GmbH & Co. KG**  
An der Schusterinsel 7  
D - 51379 Leverkusen-Opladen  
Tel. +49 (0)21 71/7212-0  
Fax +49 (0)21 71/7212-10  
info@luxelements.de  
www.luxelements.com

**F LUX ELEMENTS S.A.S**  
ZI-31, rue d'Ensisheim  
F - 68190 Ungersheim  
Tél. +33 (0) 3 89 83 69 79  
Fax +33 (0) 3 89 48 83 27  
info@luxelements.fr  
www.luxelements.fr